

Basler IP Camera



User's Manual

Document Number: AW000721

Version: 07 Language: 000 (English)

Release Date: 26 June 2010



Contacting Basler Support Worldwide

Europe and the Middle East:

Basler AG
An der Strusbek 60 - 62
22926 Ahrensburg
Germany

Phone: +49-4102-463-303
Fax: +49-4102-463-599
Email: bc.support.ip.emea@baslerweb.com

The Americas:

Basler, Inc.
855 Springdale Drive, Suite 203
Exton, PA 19341
U.S.A.

Phone: +1-610-280-0171
Fax: +1-610-280-7608
Email: bc.support.ip.usa@baslerweb.com

Asia:

Basler Asia Pte. Ltd
8 Boon Lay Way
03 - 03 Tradehub 21
Singapore 609964

Phone: +65-6425-0472
Fax: +65-6425-0473
Email: bc.support.ip.asia@baslerweb.com

www.basler-ipcam.com

All material in this publication is subject to change without notice and is copyright Basler Vision Technologies.

Table of Contents

1	Introduction	1
1.1	About this Document	1
1.2	Precautions	2
1.3	Overview	3
2	Accessing the Camera	5
3	Configuring the Camera	7
3.1	Introduction	7
3.2	Accessing the Configuration Tools and Camera Parameters	10
3.3	Image Control Parameters	12
3.4	Streaming Parameters	18
3.5	Motion Detection Parameters	34
3.6	Alarm Handling Parameters	36
3.7	Network Parameters	42
3.8	Input / Output Parameters	45
3.9	User Parameters	47
3.10	System Parameters	53
4	Reset Tool	63
5	The Terminal Connector	65
6	Day/Night Functionality	71
6.1	Introduction	71
6.2	IR-Cut Filter Control Options	74
7	Technical Specifications	77
7.1	BIP-640c and BIP1000c Specifications	77
7.2	BIP-1300c and BIP-1600c Specifications	79
7.3	Stress Test Results	81
	Revision History	85
	Feedback	89
	Index	91

1 Introduction

1.1 About this Document

This document is intended for administrative users of the camera. Previous experience with networking will be a great help when using this document.

This document assumes that you have already followed the instructions in the *Basler IP Camera Installation Guide* to install your camera.

Firmware

This document applies to cameras with version 2.0-0 firmware. Cameras with earlier or later versions of the firmware may have different features than those described here and may look different when accessed with the Basler Surveillance Web Client.

To ensure that your camera's functionality is up to date, you should periodically check the Downloads section of the Basler IP Camera website to see if a firmware update file is available. The website address is: www.basler-ipcam.com

You can view the current firmware version in a camera, and you can apply a firmware update in two different ways:

- By using the Basler Web Surveillance Client.

After you access a camera using the client (as described in Section 3.2 on [page 10](#)), you can use the Info tab in the System parameters group to view the current firmware version in the camera (see Section 3.10.1 on [page 53](#)).

If you need to update the firmware, you can use the Start Firmware Update button on the Management Tab in the System parameters group to apply a new firmware file to the camera (as described in Section 3.10.3 on [page 56](#)).

- By using the Basler IP Camera Finder software (version 1.4 or higher).

An advantage of the BIP Finder software is that it will let you view the firmware versions on several cameras at once, and it will let you apply a new firmware file to several cameras simultaneously.

Refer to the BIP Finder help file for information about how to view firmware versions and how to update the camera firmware (the help file is a separate file that is included along with the BIP Finder software).

The Basler IP Camera Finder software is available in the Downloads section of our website: www.basler-ipcam.com

1.2 Precautions



WARNING

The camera is not designed for use in an explosive atmosphere.

1. If you use the camera in an explosive atmosphere, it must be enclosed within an appropriate environmental housing.



CAUTION

Electrical Shock Hazard

Touching the camera's internal components may result in an electrical shock.

1. Do not open the camera housing. The housing contains no user serviceable parts.

NOTICE

The camera is not designed for outdoor use and can be damaged by excessively damp or wet conditions.

1. If you are using the camera outdoors, you should mount the camera in a weatherproof housing.

WEEE Directive

The European Union has enacted Directive 2002/96/EC on Waste Electrical and Electronic Equipment (the WEEE Directive). This directive is only applicable in European Union member states.

All Basler IP Cameras have been manufactured after the 31st of August 2005.

1.3 Overview

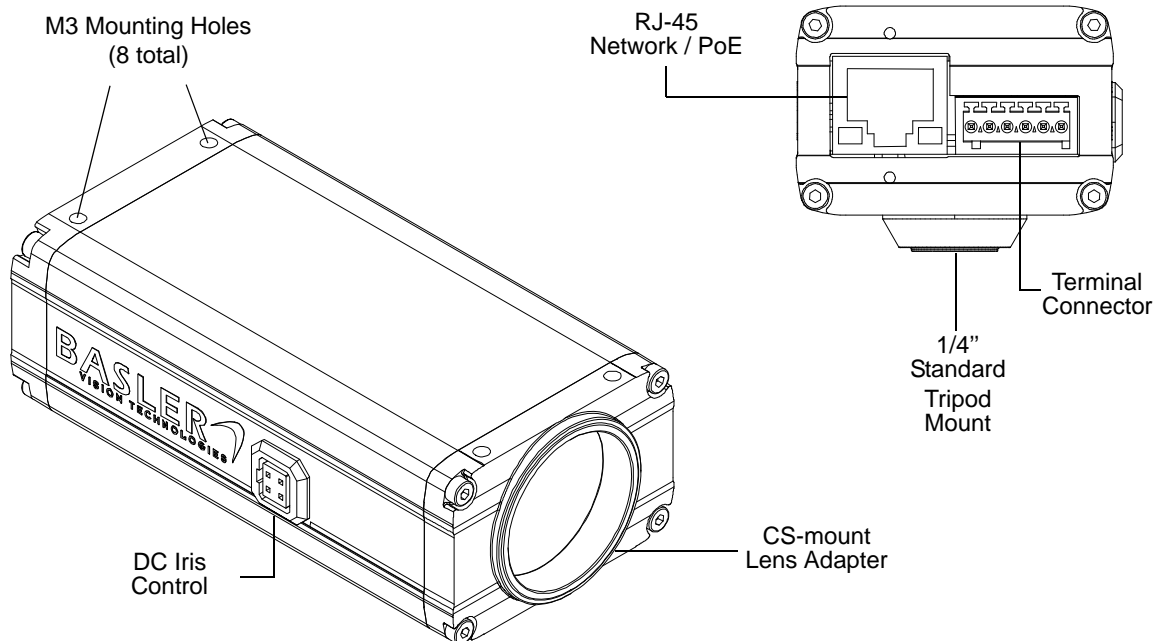

Fig. 1: Camera Connections

- **RJ-45 Network / PoE** - Provides a 10/100 Ethernet connection and can be used to connect Power over Ethernet (IEEE 802.3af) to the camera.
- **Terminal Connector** - Provides connections for a direct power input to the camera, connections for the camera's input and output lines, and connections for a standard RS-232 serial port that can be used to control an external device. See Section 5 on [page 65](#) for detailed information about the terminal connector.
- **DC Iris Control** - Provides a connection for a DC auto iris.
- **CS-mount Lens Adapter** - Provides a point to mount a CS-mount lens or a C-mount lens on the camera (a 5 mm extension tube is required with a C-mount lens).

2 Accessing the Camera

The following instructions assume that you have used the *Basler IP Camera Installation Guide* to install your camera and that you know either the IP Address or the host name of your camera.

Your camera can be accessed from most standard operating systems using a web browser. The recommended browser is Windows™ Internet Explorer 6.0 or higher.

Accessing the Camera From a Web Browser

1. Start your web browser.
2. If you know the IP Address of your camera, type the IP Address into the Address field of your browser and press the Enter key. For example: `http://172.17.1.44`
(If you don't know the IP address you can find it using the Basler BIP Finder software as described in the *Basler IP Camera Installation Guide*.)

If you know the host name of your camera and if your network has a properly configured domain name server, type the host name into the Address field of your browser and press the Enter key. For example, for a camera with a host name of `Basler-12345678` you would enter:
`http://basler-12345678`

3. Your browser will connect to the camera's web server and the Basler Surveillance Web Client will be displayed. Assuming that the camera is set to the defaults, a live MJPEG video stream will be displayed in the **Live Stream 0** tab as shown below.

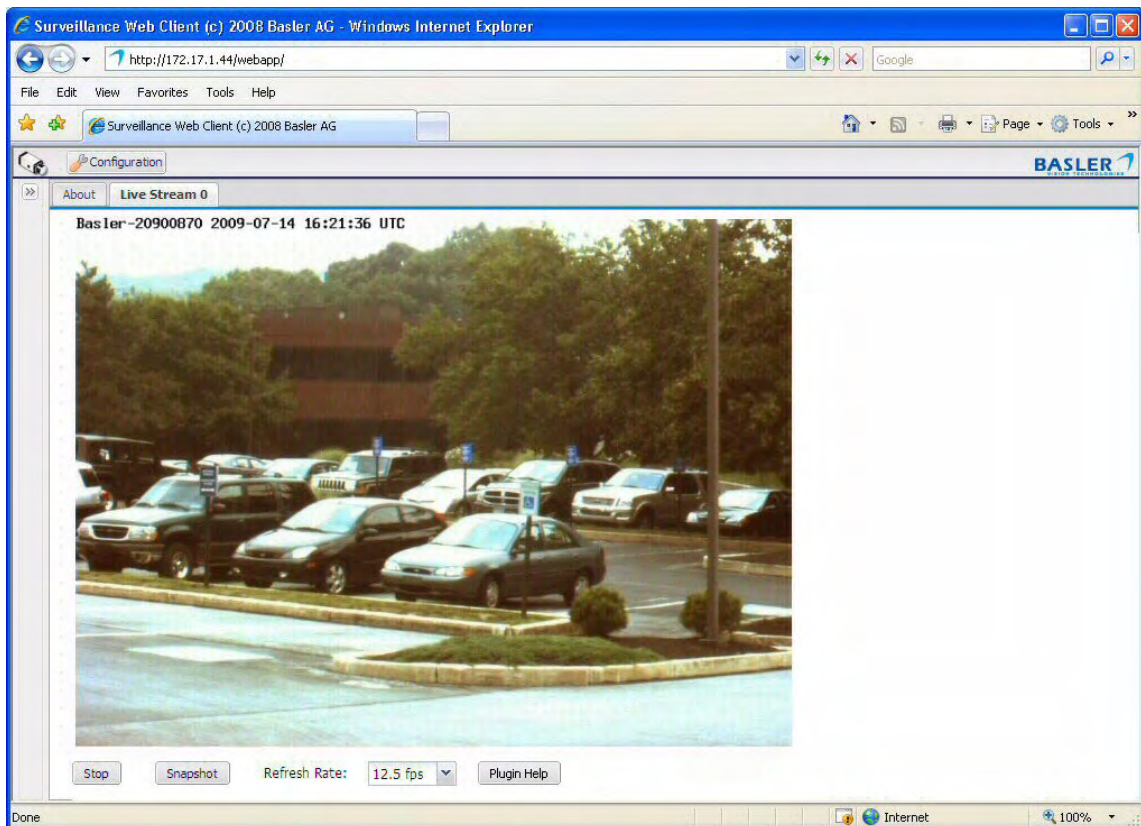

3 Configuring the Camera

This section describes how to configure your camera. It is intended to be used by administrators who have full access rights to the camera.

3.1 Introduction

When adjusting the parameters used to configure the camera, it helps to have an overview of the camera's functionality in mind. Figure 2 on [page 9](#) shows a block diagram of the camera outlining the basic functional units in the camera and shows how they are related.

As shown in Figure 2, the camera includes a sensor that captures images. The images are passed from the sensor to a microprocessor. In the microprocessor, a variety of tasks are performed on the captured images, such as white balancing and motion detection. Note that there is a path from the microprocessor to the imaging sensor. This path allows the processor to control how the sensor will capture images (e.g., the size of the image area captured and the image capture rate).

Once images are captured and processed, they are passed to three separate video encoders in the camera. These encoders are designated as the stream 0 encoder, the stream 1 encoder, and the stream 2 encoder. Each encoder can be configured separately. The stream 0 encoder is always enabled and can be configured to use MJPEG (motion JPEG), MPEG4, or H.264 video encoding. The stream 1 and stream 2 encoders can be enabled or disabled by the user, and these two streams can only be set to use MJPEG video encoding.

Each encoder feeds a live buffer and an alarm buffer. As shown in the drawing, multiple network devices (usually computers) can access each encoder stream. A device can access the live buffer for a stream, the alarm buffer for a stream, or both. A device can also open multiple connections to the camera's streams (each connection is commonly referred to as a "network stream").

In essence, the camera can produce up to three differently configured video streams and each stream can be accessed by multiple network users.

Normal Operating Mode and Configuration Mode

As shown in Figure 2, there are groups of parameters that affect the functionality of the camera at various stages of its operation. You configure the camera by setting these parameters.

When the camera is in its "normal" operating mode, it captures images, processes them, encodes them, and streams them to external devices via the network connection. In normal mode, most of the camera's parameters can be changed, and a change to a parameter will have an immediate effect on the operation of the camera. If you take a look at the screen shot of the Basler Surveillance Web Client on [page 11](#), you will see a list of parameter groups on the left side, such as Image Controls, Streaming, Motion Detection, Alarm Handling, etc. Except for the Streaming group, the parameters in each group can be adjusted while the camera is in normal mode.

The parameters in the Streaming group can only be adjusted when the camera is in "configuration" mode. When you open the Streaming parameters group in the web client, the camera will automatically be placed in the configuration mode. Any changes you make to the parameters in the Streaming group will not take effect until you close the group. The camera will apply any changes and will automatically return to normal mode when you close the Streaming group.



The camera will continue to capture and stream images normally while it is in configuration mode.

If you change the Live Buffer Size parameter setting or the Alarm Buffer Size parameter setting for any stream, the setting changes will be applied when you switch back to the Normal mode and **all streams** will be stopped and restarted.

If you change the Encoder Type parameter setting, the Output Scaling parameter setting, the AOI Width parameter setting, or the AOI Height parameter setting for any one of the streams, the setting changes will be applied when you switch back to Normal mode and that stream will be stopped and restarted.

(Keep in mind that if you change the sensor AOI Width and AOI Height settings to values that are smaller than the current stream AOI Width and AOI Height settings, the camera will automatically make the stream AOI Width and AOI Height settings smaller.)

Capture Frame Rate and Stream Frame Rate

An image that has been captured by the camera is commonly called a "frame", and the rate at which the camera captures images is referred to as the "frame rate". Normally, the camera will attempt to encode and stream frames at the same rate at which they are being captured by the imaging sensor. But there are several factors that can limit this capability.

If you are capturing images using the full image area of the sensor, it may put such a large load on the encoder(s) that they will not be able to encode and stream every image captured by the sensor. This is especially true if multiple encoders are enabled and if many devices are accessing the stream from each encoder. If the encoders cannot encode and stream images at the same rate that the sensor is capturing them, the encoders will simply drop some of the captured images and encode at a lower rate. You could address this situation by decreasing the size of the images captured by the imaging sensor, i.e., decreasing the sensor AOI (see Section 3.4.1 on [page 19](#)). This will decrease the load on the encoders and allow them to encode at a higher rate.

Another factor that can affect the rate at which the encoders encode and stream images is the general load on the camera's microprocessor. If you have enabled many of the camera's functions simultaneously, it could place a high load on the camera's microprocessor and thus decrease the microprocessor's ability to operate the encoders. For example, if you enabled motion detection with a large mask area and fine granularity, you enabled several alarm sources and alarm actions, and you enabled serial port forwarding, you may find that the encoders are encoding at a rate that is lower than images are being captured by the sensor.

Note that there is an easy way to determine the current rate at which an encoder is encoding and streaming images. If you simply add the \$fps\$ expression to the text overlay setup for the stream, the text overlay on the streamed images will display the current rate at which the images are being encoded and streamed. For example, if you added the \$fps\$ expression to the text overlay setup

for encoder stream 0, the images in stream 0 would display the current rate in the text overlay. See Section 3.4.1 on [page 19](#) for more information about setting text overlays.

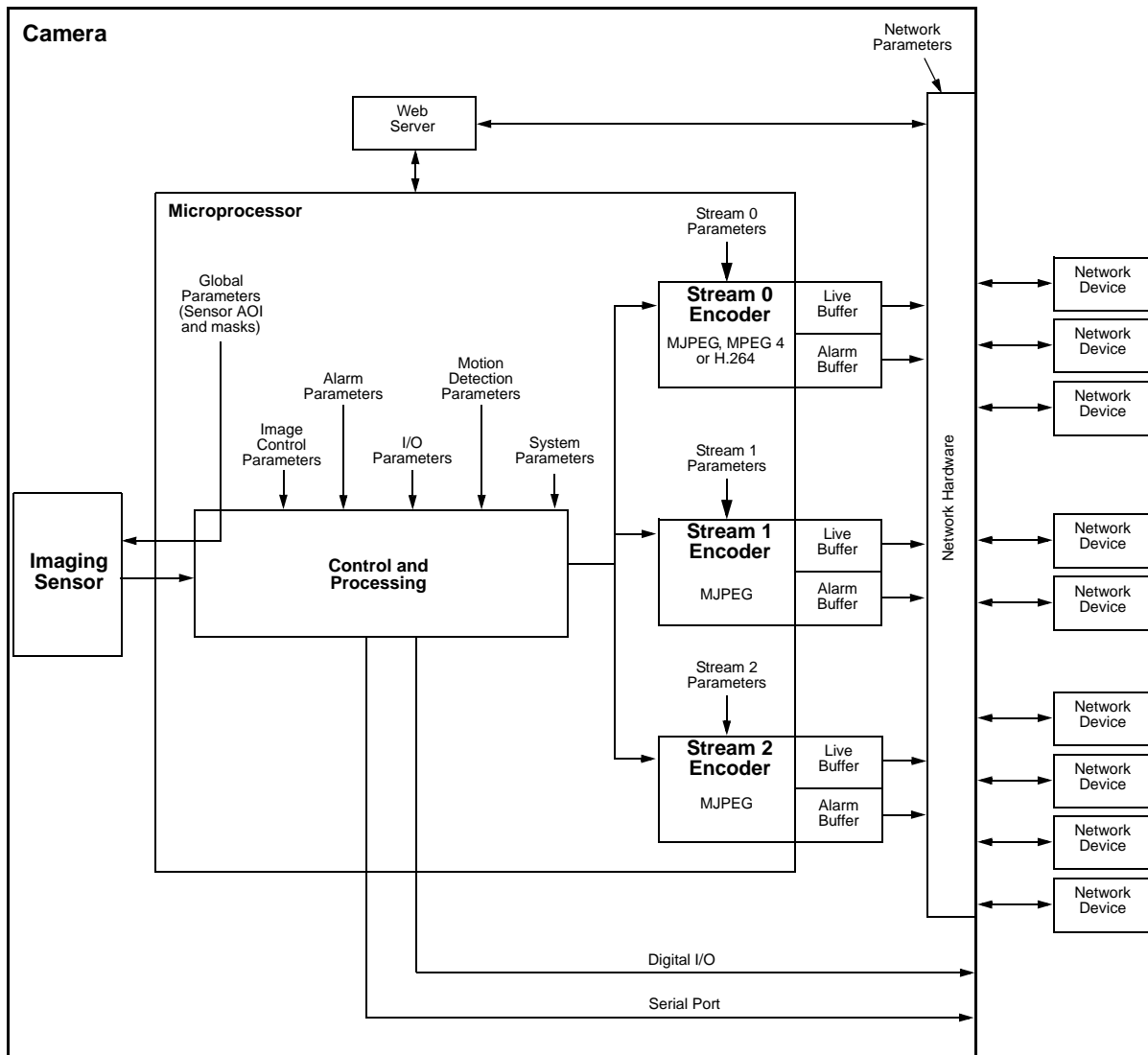
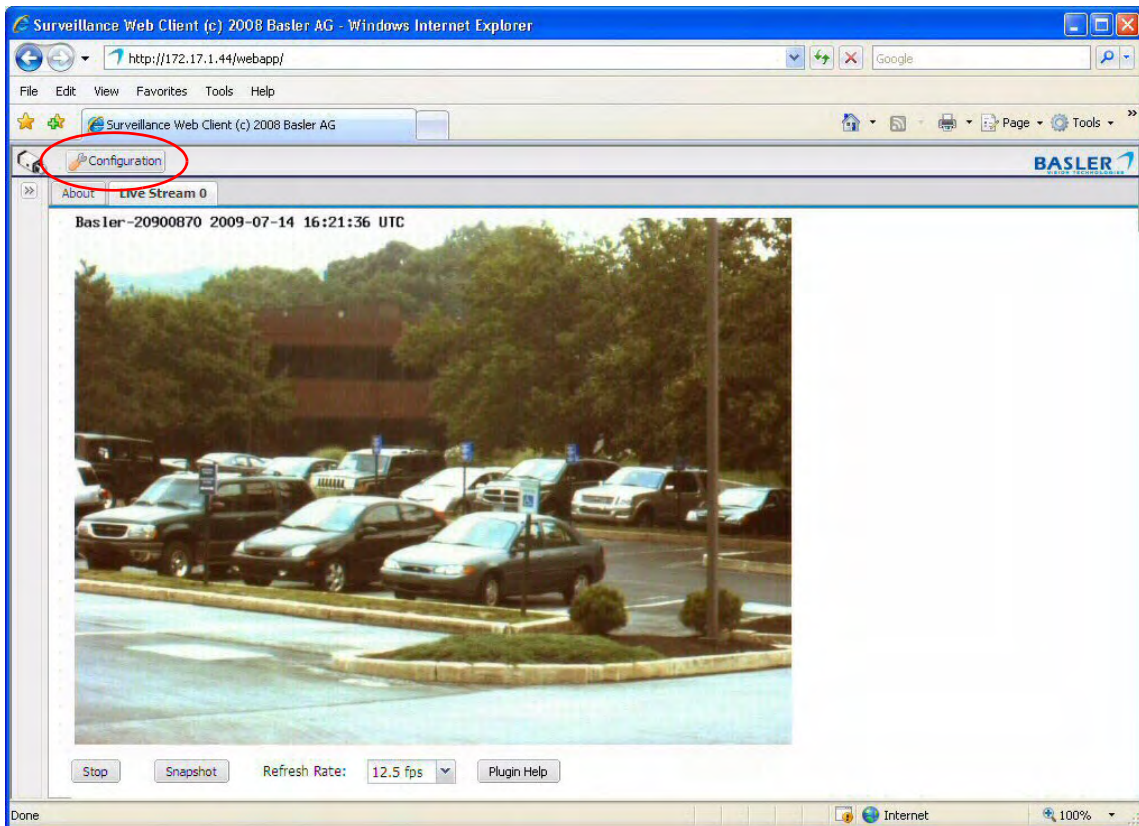

Fig. 2: Camera Block Diagram

3.2 Accessing the Configuration Tools and Camera Parameters

1. If you have not already done so, start your web browser and access the Basler Surveillance Web Client in your camera as described in Section 2 on [page 5](#).
2. When the Basler Surveillance Web Client opens as shown below, click the **Configuration** button on the left side of the Basler tool bar.



3. A **Camera Configuration** menu will open on the left side of the client as shown below. Notice that the parameters used to configure the camera appear in groups such as the **Image Controls** group and the **Streaming** group.

You can open a parameter group by clicking the + sign beside the group name.

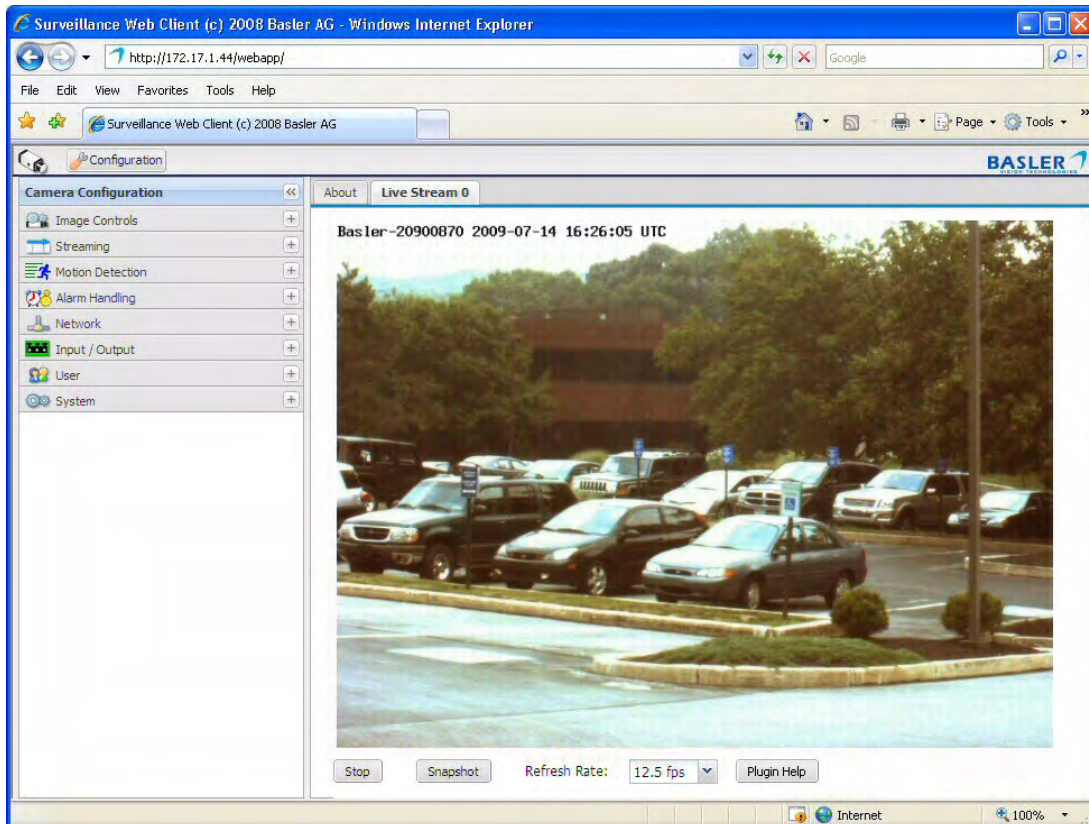

By default, the camera is set so that video stream 0 is an MJPEG stream, and a **Live Stream 0** tab will appear in the client as shown above. A live video stream will appear in the tab.

If more than one video stream is enabled, there will be an additional **Live Stream** tab available for each enabled stream.

Click the **Stop** button to stop live image streaming. (A **Start** button will appear, which will let you restart the live stream.)

Click the **Snapshot** button to capture a single image within a new browser window.

Refresh Rate - The **Refresh Rate** box displays the rate at which the images displayed in the web client are refreshed. Use the button to change the refresh rate.

Note that changing the **Refresh Rate** setting will not change the rate at which the camera captures or streams images. The **Refresh Rate** setting only affects the rate at which images are displayed in the web client in your browser. Some browsers perform poorly when set to a high refresh rate. Opening and closing parameter groups or switching from one tab to another will work very slowly if the refresh rate is too high. A refresh rate of 5 fps works well in most situations.

Click the **Plugin Help** button to get information about installing the plugins needed to view live streams in your web browser.

3.3 Image Control Parameters

The parameters in the **Image Controls** group control the quality of the images captured by the camera's imaging sensor.

3.3.1 Exposure Tab

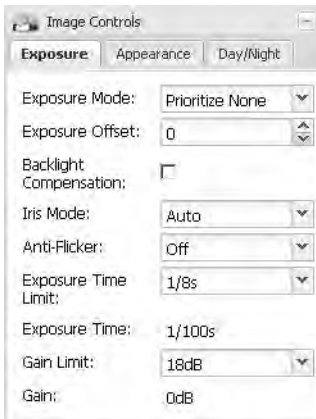

Exposure Mode - Sets the camera's exposure mode.

- Prioritize None** = Automatic exposure time control and automatic gain control are both enabled. The camera will automatically adjust both the exposure time and the gain to maintain good overall image quality as lighting conditions change. Neither the exposure time adjustment nor the gain adjustment will have priority.

If desired, the **Exposure Time Limit** and the **Gain Limit** parameters (see below) can be used to put limits on the auto controls.

- Prioritize Framerate** = Automatic exposure time control and automatic gain control are both enabled. The camera's automatic exposure and gain adjustments will be biased so that the frame rate is maintained at as high a level as possible. Maintaining image quality is given a lower priority.

If desired, the **Exposure Time Limit** and the **Gain Limit** parameters (see below) can be used to put limits on the auto controls.

- Prioritize Quality** = Automatic exposure time control and automatic gain control are both enabled. The camera's automatic exposure and gain adjustments will be biased so that image quality is maintained at as high a level as possible. Maintaining the frame rate is given a lower priority.

If desired, the **Exposure Time Limit** and the **Gain Limit** parameters (see below) can be used to put limits on the auto controls.

- Manual Gain** = Automatic gain control is disabled, and you must manually set the gain by using the **Gain** parameter (see below).

Automatic exposure time control remains enabled. If desired, the **Exposure Time Limit** parameter (see below) can be used to put a limit on the auto exposure control.

- Manual Exposure Time** = Automatic exposure time control is disabled, and you must manually set the exposure time by using the **Exposure Time** parameter (see below).

Automatic gain control remains enabled. If desired, the **Gain Limit** parameter (see below) can be used to put a limit on the auto gain control.

- Manual Gain and Exposure Time** = Automatic gain control and automatic exposure time control are both disabled. You must manually set the gain and the exposure time by using the **Gain** and **Exposure Time** parameters (see below).

Note that the operation of the automatic gain and exposure time controls will be strongly influenced by the placement of the auto brightness mask. For more information about the auto brightness mask, see [page 23](#).

Exposure Offset - Is used to customize the operation of the camera's automatic controls. Negative settings will bias the auto controls toward producing darker images. Positive settings will bias the auto controls toward producing lighter images.

Backlight Compensation - Check the box to enable the camera's backlight compensation feature. This feature automatically compensates when the main lighting comes from behind the image subject.

Iris Mode - Sets the camera's iris mode.

- **Auto** = The iris will be automatically controlled by the camera.
- **Open** = The iris is fully open.
- **Closed** = The iris is fully closed.
- **Prioritize Open** = the iris control will attempt to keep the iris as open as possible while still maintaining good image quality.
- **Prioritize Closed** = the iris control will attempt to keep the iris as closed as possible while still maintaining good image quality.

The **Open** and **Closed** settings can be used to test the functionality of an iris mechanism.

The **Prioritize Open** and **Prioritize Closed** settings may improve image quality in certain situations. Trying these settings under your actual conditions is the best way to determine whether one of the settings is appropriate for your application.

Note that the operation of the automatic iris control will be strongly influenced by the placement of the auto brightness mask. For more information about the auto brightness mask, see [page 23](#).

Anti-Flicker - Enables or disables the anti-flicker feature. If the camera is operating in an environment where the lighting flickers at a 50 Hz or a 60 Hz rate (such as incandescent or fluorescent lights), the flickering lights can cause significant changes in brightness from image to image. Enabling the anti-flicker feature may reduce the effect of the flickering in the captured images

Note that the **Anti-Flicker** feature will only be available when the **Exposure Mode** parameter (see above) is set to one of the "prioritize" modes.

Exposure Time Limit - When automatic exposure time control is enabled (see **Exposure Mode** above), the **Exposure Time Limit** parameter sets the maximum exposure time that the automatic exposure control can use. If the exposure time limit is set to "off", there will be no limit for the automatic exposure control.

Note that if the **Anti-Flicker** feature is enabled, the **Exposure Time Limit** parameter setting must be 1/60s or greater.

Exposure Time - When automatic exposure time control is disabled (see **Exposure Mode** above), the **Exposure Time** parameter sets the exposure time for the captured images.

Note that if automatic exposure time control is enabled, the **Exposure Time** parameter will be read only and will indicate the current exposure time value as set by the automatic control.

Gain Limit - When automatic gain control is enabled, (see **Exposure Mode** above) the **Gain Limit** parameter sets the maximum amount of gain that the automatic gain control can use. If the gain limit is set to "off", there will be no limit for the automatic gain control.

Note that if the **Anti-Flicker** feature is enabled, the **Gain Limit** parameter setting must be 6dB or greater.

Gain - When automatic gain control is disabled (see **Exposure Mode** above), the **Gain** parameter sets the gain for the captured images. Gain refers to the amount of amplification that is applied to the pixel values in each captured image. A higher setting means more amplification.

Note that if automatic gain control is enabled, the **Gain** parameter will be read only and will indicate the current gain value as set by the automatic control.

3.3.2 Appearance Tab

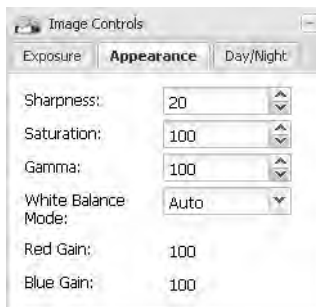

Sharpness - Sets the sharpness of the images transmitted by the camera. Higher settings produce sharper images.

Saturation- Sets the color saturation of the images transmitted by the camera. Higher settings produce more saturated (colorful) images.

Gamma - Sets the degree of gamma correction applied to captured images. Gamma corrects the captured images for non-linearities in the human eye's perception of brightness.

A setting of 100 represents a gamma correction factor of 1, and the appearance of the captured images will not be changed. A setting of 50 represents a gamma correction factor of 0.5. A setting of 150 represents a gamma correction factor of 1.5.

White Balance Mode - Sets the camera's automatic white balance mode.

- **Auto** = The camera will automatically adjust the white balance and the white balance adjustments will be continuously updated as lighting conditions change. The white balance control will assume average lighting conditions.

The automatic white balance control attempts to continuously balance the intensity of the red, green, and blue pixels in the captured images so that the white areas of the captured images always appear white (and not, for example, red tinted or green tinted).

Note that the operation of the automatic white balancing function will be strongly influenced by the placement of the white balance mask. For more information about the white balance mask, see [page 22](#).

- **Automatic Preset** = The camera will attempt to identify the type of lighting present (i.e., daylight, incandescent, fluorescent, etc.) and then will automatically adjust the white balance based on the lighting type detected. This selection works best when the lighting conditions are uniform.
- **Daylight** = The camera will automatically change the white balance settings so that they are biased for daylight lighting conditions (a color temperature of 5500 K). Once the settings are changed, the white balance will stay fixed at that point.
- **Incandescent** = The camera will automatically change the white balance settings so that they are biased for incandescent lighting (a color temperature of 3000 K). Once the settings are changed, the white balance will stay fixed at that point.
- **Fluorescent I** = The camera will automatically change the white balance settings so that they are biased for normal fluorescent lighting (a color temperature of 2700 K). Once the settings are changed, the white balance will stay fixed at that point.
- **Fluorescent II** = The camera will automatically change the white balance settings so that they are biased for bright fluorescent lighting (a color temperature of 4000 K). Once the settings are changed, the white balance will stay fixed at that point.
- **Manual** = White balance is manually controlled. You can adjust the white balance by using the **Red Gain** and **Blue Gain** parameters (see below).

Red Gain - If the **White Balance Mode** parameter (see above) is set to manual, then the **Red Gain** parameter can be used to adjust the intensity of the red in the captured images. Decrease the setting to make the images less red, and increase the setting to make the images more red.

Note that if the **White Balance Mode** parameter is set to a value other than manual, the **Red Gain** parameter will be read only and will indicate the current red gain value as set by the automatic white balance control.

Blue Gain - If the **White Balance Mode** parameter (see above) is set to manual, then the **Blue Gain** parameter can be used to adjust the intensity of the blue in the captured images. Decrease the setting to make the images less blue, and increase the setting to make the images more blue.

Note that if the **White Balance Mode** parameter is set to a value other than manual, the **Blue Gain** parameter will be read only and will indicate the current blue gain value as set by the automatic white balance control.

3.3.3 Day/Night Tab

Note: The settings on this tab will only be adjustable on day/night models of the camera. On non-day/night cameras, the parameter values will be indicated as "Fixed" or "Not Available".

Section 6 on [page 71](#) provides detailed information about how the camera's day/night functionality works. We recommend that you read this section before you set the parameters on the day/night tab.

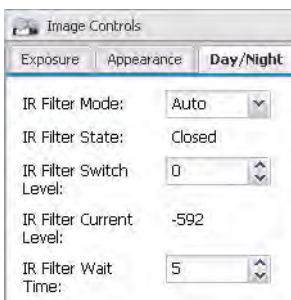

IR Filter Mode - Sets the mode of operation for the camera's IR-cut filter.

- **Auto** = The camera automatically senses the change from night to day or from day to night and sets the position of the camera's IR-cut filter accordingly.
- **Open** = Move the IR-cut filter to the open position and keep it there.
- **Closed** = Move the IR-cut filter to the closed position and keep it there.
- **Input Pin 0 Controlled** = The position of the IR-cut filter will be controlled by the state of the camera's input pin 0.

IR Filter State - Indicates the current state of the camera's IR-cut filter.

- **Open** = The IR-cut filter is currently in the open position.
- **Closed** = The IR-cut filter is currently in the closed position.

IR Filter Switch Level - When the **IR Filter Mode** parameter is set to auto, the **IR Filter Switch Level** setting is mainly used to adjust when the camera will switch from day mode to night mode. The higher the **IR Filter Switch Level** setting, the darker it must be before the camera will make the switch. Setting the switch level to a higher value typically means that the camera will switch from day mode to night mode later in the day, i.e., when it is darker.

If the current level of darkness (as indicated by the **IR Filter Current Level** parameter) rises above the switch level setting and remains there longer than the **IR Filter Wait Time** (see below), the camera will switch from day mode to night mode.

If the current level of darkness (as indicated by the **IR Filter Current Level** parameter) falls below the switch level setting and remains there longer than the **IR Filter Wait Time** (see below), the camera will switch from night mode to day mode.

IR Filter Current Level - Indicates the current level of darkness as measured by the camera's auto IR filter control. As the area being viewed by the camera gets darker, the value of the **IR Filter Current Level** will rise (a high positive value indicates that the area being viewed is very dark). As the area being viewed by the camera becomes brighter, the value of the **IR Filter Current Level** will fall (a large negative value indicates that the area being viewed is very bright).

IR Filter Wait Time - Sets the amount of time in seconds that the value of the **IR Filter Current Level** must remain above the **IR Filter Switch Level** setting before the camera will switch from day mode to night mode. It also sets the amount of time in seconds that the value of the **IR Filter Current Level** must remain below the **IR Filter Switch Level** setting before the camera will switch from night mode to day mode.



A feature called the IR filter announce mode can be set to use the camera's digital output pin to "announce" the current state (open or closed) of the IR-cut filter. For more information, see Section 3.8.1 on [page 45](#) and see [page 73](#).

3.4 Streaming Parameters

The parameters in the **Streaming** group are used to control the characteristics of the image area that will be captured by the camera's sensor. They are also used to control the characteristics of the video streams that are output from the camera.

The camera can produce up to three individually configured video streams. The streams are designated as stream 0, stream 1, and stream 2. Stream 0 is always enabled. Streams 1 and 2 can be either enabled or disabled. Each stream can be accessed by multiple network users.

For more information about video streams, see Section 3.1 on [page 7](#).



When you open the **Streaming** parameters group, the camera enters the "configuration" mode. When you close the **Streaming** parameters group, the camera will return to "normal" mode and any parameter changes you made will be applied.

When the **Streaming** parameters group is open, the images displayed on any editor tabs in the web client will be refreshed approximately once per second.

3.4.1 Global Tab

The parameters on the **Global** tab control the way that the camera's imaging sensor will capture images. Because the images captured by the sensor are used for all three video streams, the parameters on this tab are considered to be "global", i.e., changes made here will affect what you can do when you work with the individual stream parameters.

Some of the parameters in this group are used to set the imaging sensor's "area of interest" (AOI). The sensor AOI settings let you define the area on the sensor that will actually be used when the camera is capturing images. You can set the AOI settings so that the full sensor is used to capture images or so that just a portion of the sensor is used as shown in Figure 3.

The sensor AOI Width and sensor AOI Height parameters define the width and height (in pixels) of the image area that will be captured. The sensor AOI Top and sensor AOI Left parameters define where the image area will be located in relation to the top left corner of the sensor.

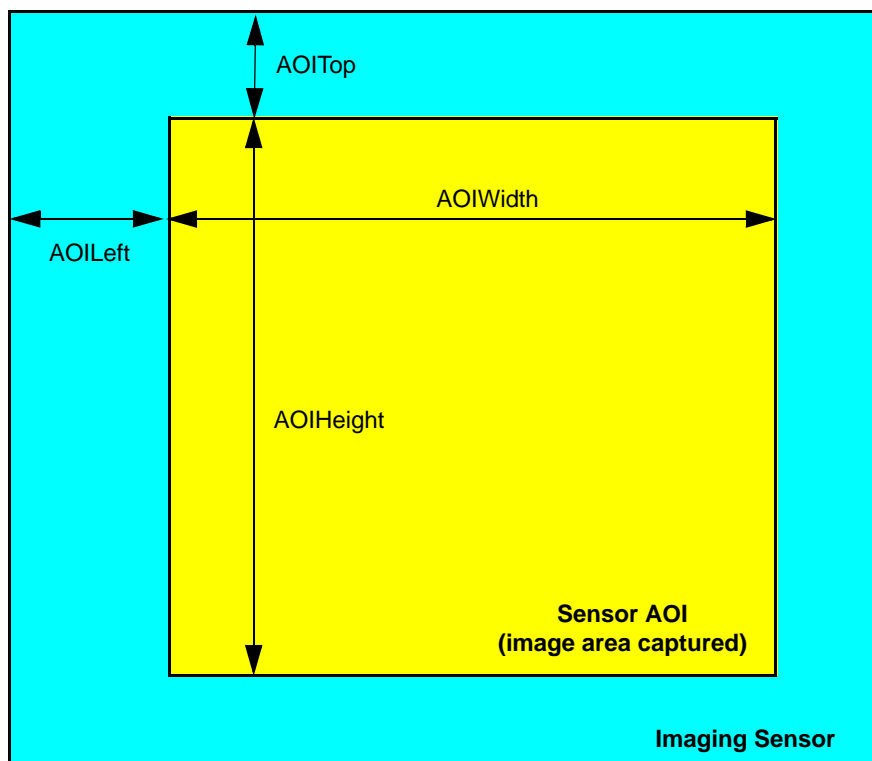
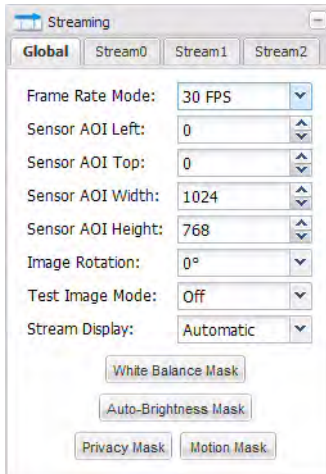

Fig. 3: Sensor AOI

Why Decrease the Sensor AOI Size?

On some camera models, typically those with large imaging sensors, the maximum rate at which the sensor can capture images (i.e., the frame rate) is limited. On these cameras, when you decrease the height of the sensor AOI, the rate at which the sensor can capture images will increase. So if you need to capture images at a higher rate, decreasing the size of the sensor AOI may be a workable option that will allow you to do so.



Frame Rate Mode - Sets the rate at which the camera's sensor will capture frames (images). For example, selecting 15 FPS means that the camera's imaging sensor will capture 15 frames per second.

Note that on some camera models, typically those with large imaging sensors, the maximum rate at which the sensor can capture images (i.e., the frame rate) is limited. On these cameras, if you decrease the height of the sensor AOI, the rate at which the sensor can capture images will increase. So if you decrease the setting for the **AOI Height** parameter, you may see an increase in the maximum setting available for the **Frame Rate Mode** parameter.

Sensor AOI Left - As shown in Figure 3 on [page 19](#), sets the left offset (in pixels) for the sensor AOI, i.e., how far the sensor AOI will be offset from the left edge of the sensor. The setting must be a multiple of 2.*

Sensor AOI Top - As shown in Figure 3 on [page 19](#), sets the top offset (in pixels) for the sensor AOI, i.e., how far the sensor AOI will be offset from the top edge of the sensor. The setting must be a multiple of 2.*

Sensor AOI Width - As shown in Figure 3 on [page 19](#), sets the width (in pixels) of the sensor AOI. The setting must be a multiple of 8.*

Sensor AOI Height - As shown in Figure 3 on [page 19](#), sets the height (in pixels) of the sensor AOI. The setting must be a multiple of 8.*

* You can also use the **Sensor AOI Editor** (see [page 21](#)) to set this parameter, and any changes you make to the AOI parameter settings on the **Global** tab will be reflected on the **Sensor AOI Editor**.

Image Rotation - Sets the degrees of rotation for the images captured by the sensor.

- **0°** = Don't rotate the images.
- **180°** = Rotate the images 180 degrees.

Test Image Mode - Enables or disables the camera's test image feature. When the test image mode is enabled, the camera will generate test images using its digital devices rather than the imaging sensor. The generated test images will be transmitted on all enabled streams. Test images are useful for troubleshooting the camera's basic functionality and the network connection.

- **Off** = The test image function is disabled.
- **On** = The test image functioned is enabled. The camera will stream test images that include diagonal red, green, and blue gradients. The gradients will appear to move as the test images are received.

Stream Display - Selects the plugin that will be used to display encoded images in the web client's stream tabs.

- **Automatic** = Automatically selects the most appropriate plugin from the plugins currently installed on your web browser.
- **No Display** = Display of image streams within the web client is disabled. You will still be able to change parameter settings. This is a good choice if you only want to use the web client to change settings. Access to the settings is faster with image display disabled.
- **Basler Plugin** = Select the Basler plugin. The Basler Plugin is a good choice for displaying the images. Note that if you have not installed the Basler ActiveX control on your browser, the Basler Plugin will not be available for selection.
- **"Plugin Name" Plugin** = Select the "Plugin Name" plugin. Depending on what plugins you have installed on your web browser, several different plugins may be listed. Each plugin will be listed by name. A plugin will only be listed here if it has been installed and can display the encoded images.

Sensor AOI Editor - Whenever the **Global** tab is selected, a **Sensor AOI Editor** screen will also be available as shown below. You can use the editor to set the sensor AOI size and position rather than setting numbers in the boxes on the **Global** tab. To set the sensor AOI with the editor, simply use your cursor to drag the edges of the red rectangle that represents the sensor AOI. You can also use the buttons at the bottom of the editor to set the AOI to the full size of the sensor, to set the AOI to 1/4 of the sensor's size, to align the AOI to the top left side of the sensor, or to center the AOI on the sensor.

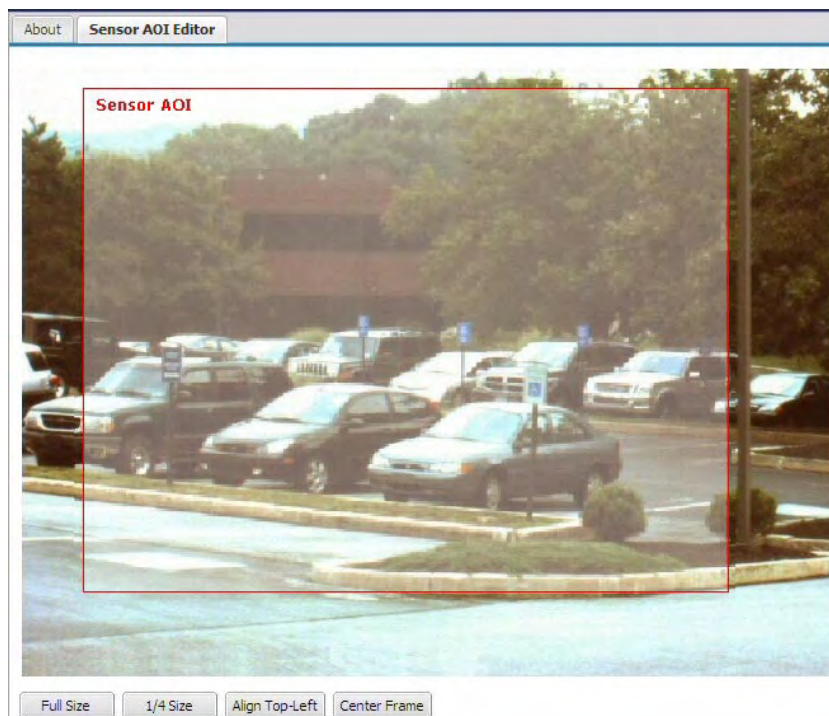

White Balance Mask

Click the **White Balance Mask** button to open the **White Balance Mask Editor** as shown below.

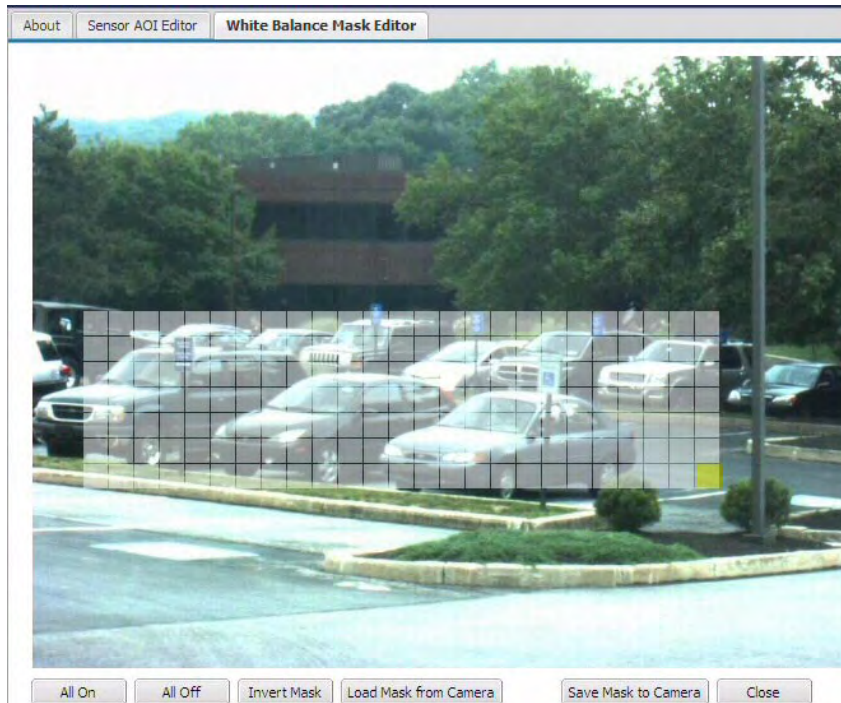

The white balance mask defines the area(s) of the image that will be used by the camera's automatic white balancing function when the **White Balance Mode** parameter is set to **Auto** (see Section 3.3 on [page 12](#)). Highlighted areas in the editor will be included in the white balance mask and unhighlighted areas will not. To highlight an area within the editor, simply left click your mouse and drag the cursor over the editor screen.

The area under the mask will be used by the automatic white balance control to define what "white" is. So you should always place the white balance mask over an area of the image that is truly a white area. If you place the mask over, for example, a green area of the image, you will find that the color balance in your captured images is badly skewed when the **White Balance Mode** parameter is set to **Auto**.

Note that you can set the mask so that it covers a single area as shown above or so that it covers several different areas within the image.

You can use the **All On** button at the bottom of the screen to highlight all areas of the editor and the **All Off** button to unhighlight all areas. Use the **Invert Mask** button to swap the highlighted areas and the unhighlighted areas. Clicking the **Load Mask From Camera** button will display the mask settings that are currently saved in the camera.

Any changes you make using the mask editor will not be saved in the camera until you click the **Save Mask To Camera** button. The **Close** button will close the editor.

Auto-Brightness Mask

Click the **Auto-Brightness Mask** button to open the **Auto Brightness Mask Editor** as shown below.



The auto brightness mask defines the area(s) of the image that will be used by the camera when it performs automatic exposure, gain, and iris control (see Section 3.3 on [page 12](#)). Highlighted areas in the editor will be included in the auto-brightness mask and unhighlighted areas will not. To highlight an area within the editor, simply left click your mouse and drag the cursor over the editor screen.

Normally, you should position the mask so that it covers the brightest areas of the image. This will typically yield the best performance from the automatic exposure, gain, and iris controls.

Note that you can set the mask so that it covers a single area as shown above or so that it covers several different areas within the image.

You can use the **All On** button at the bottom of the screen to highlight all areas of the editor and the **All Off** button to unhighlight all areas. Use the **Invert Mask** button to swap the highlighted areas and the unhighlighted areas. Clicking the **Load Mask From Camera** button will display the mask settings that are currently saved in the camera.

Any changes you make using the mask editor will not be saved in the camera until you click the **Save Mask To Camera** button. The **Close** button will close the editor.

Privacy Mask

Click the **Privacy Mask** button to open the **Privacy Mask Editor** as shown below.

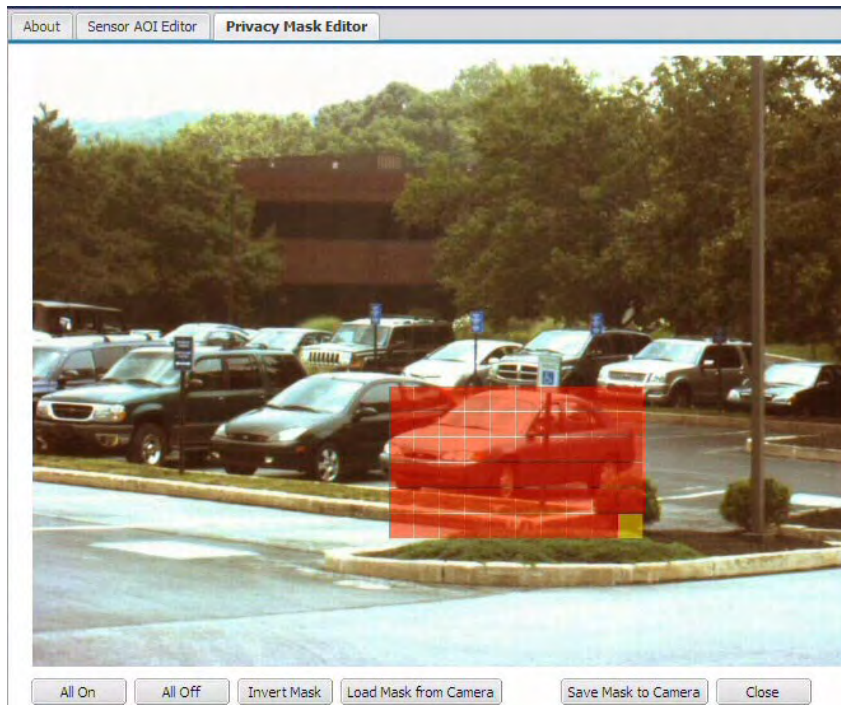

The privacy mask defines the area(s) of the image that will be blacked out in the images in the video streams. Highlighted areas in the editor will be included in the privacy mask and will be blacked out. Unhighlighted areas will not. To highlight an area within the editor, simply left click your mouse and drag the cursor over the editor screen.

Note that you can set the mask so that it covers a single area as shown above or so that it covers several different areas within the image.

You can use the **All On** button at the bottom of the screen to highlight all areas of the editor and the **All Off** button to unhighlight all areas. Use the **Invert Mask** button to swap the highlighted areas and the unhighlighted areas. Clicking the **Load Mask From Camera** button will display the mask settings that are currently saved in the camera.

Any changes you make using the mask editor will not be saved in the camera until you click the **Save Mask To Camera** button. The **Close** button will close the editor.

Motion Mask

Click the **Motion Mask** button to open the **Motion Mask Editor** as shown below.



The motion mask defines the area(s) of the image that will be used for the camera's motion detection function (see Section 3.5 on [page 34](#)). Highlighted areas in the editor will be included in the motion detection mask and used for motion detection. Unhighlighted areas will not. To highlight an area within the editor, simply left click your mouse and drag the cursor over the editor screen.

Note that you can set the mask so that it covers a single area as shown above or so that it covers several different areas within the image.

You can use the **All On** button at the bottom of the screen to highlight all areas of the editor and the **All Off** button to unhighlight all areas. Use the **Invert Mask** button to swap the highlighted areas and the unhighlighted areas. Clicking the **Load Mask From Camera** button will display the mask settings that are currently saved in the camera.

Any changes you make using the mask editor will not be saved in the camera until you click the **Save Mask To Camera** button. The **Close** button will close the editor.

3.4.2 Stream Tabs

The parameters on the **Stream 0 Tab**, **Stream 1 Tab**, and **Stream 2 Tab**, control the way that the video stream associated with the selected tab is configured.

Some of the parameters on each stream tab are used to set the "area of interest" (AOI) for the video stream controlled by the tab. The stream AOI settings on a tab let you define an area within the image area being captured by the camera's sensor and only the pixel data from the defined area will be encoded and streamed in the stream controlled by the tab. You can set the stream AOI settings so that the entire image area is encoded and streamed or so that just a portion of the image area is encoded and streamed.

The stream AOIWidth and stream AOI Height parameters define the width and height (in pixels) of the area that will be encoded and streamed. The stream AOITop and stream AOILeft parameters define where the area will be located in relation to the top left corner of the image area that was captured by the imaging sensor. (See Section 3.4.1 on [page 19](#) for more information about defining the image area captured by the sensor.)

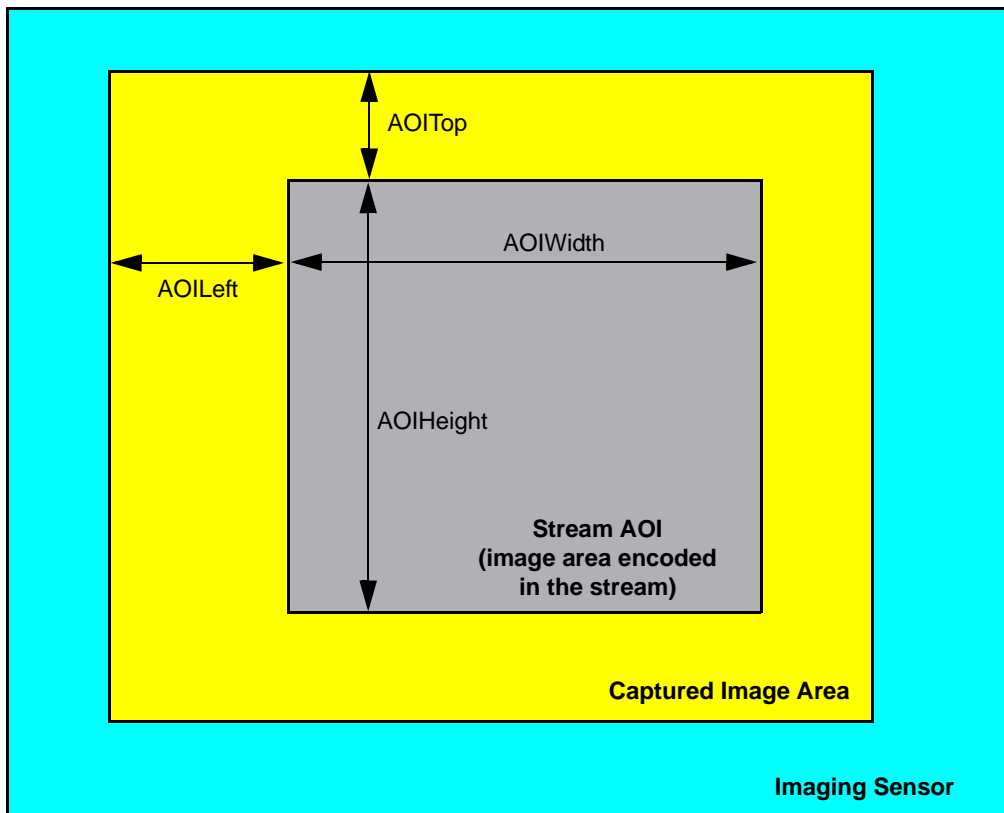
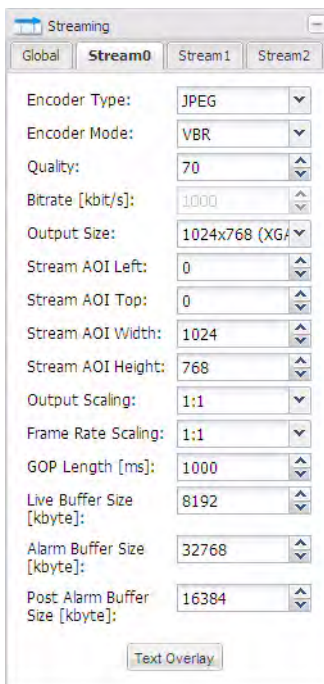

Fig. 4: Stream AOI

Why Decrease the Stream AOI Size?

In some installations, the network bandwidth available may be limited. Decreasing the size of the stream AOI will decrease the amount of data in each image. This in turn will reduce the amount of data that must be streamed across the network and thus decrease the bandwidth required.



Encoder Type - Sets the encoder type for the stream controlled by the currently selected tab.

- **Off** = The video stream is disabled and no images will be streamed. This setting is only available on the **Stream 1** and **Stream 2** tabs. Stream 0 is always enabled, and the off setting is not available for this stream.
- **JPEG** = The camera will use motion JPEG (MJPEG) encoding for the images streamed. The motion JPEG format uses standard JPEG still images to create the video stream. The stream of still images is displayed and updated at a rate that shows constantly updated motion. Although MJPEG encoding does compress the images to some degree and although this compression is usually described as "lossy", MJPEG encoding results in high quality image transmission. However, high bandwidth is required to transmit the images.
- **MPEG4** = The camera will use MPEG4 encoding for the images streamed. This setting is only available on the **Stream 0** tab; stream 1 and stream 2 can not be MPEG4 encoded. MPEG4 encoding uses more effective compression techniques than MJPEG encoding. This significantly lowers the bandwidth required to transmit the images.
- **H.264** = The camera will use H.264 encoding for the images streamed. This setting is only available on the **Stream 0** tab; stream 1 and stream 2 can not be MPEG4 encoded. H.264 encoding uses more advanced compression techniques. This yields a more significant lowering in the bandwidth required to transmit the images.

Encoder Mode - Sets the encoder mode for the stream controlled by the currently selected tab.

- **VBR** = The encoder will operate in Variable Bit Rate mode. The encoder attempts to maintain constant image quality by adjusting the output bit rate as necessary. The quality level will be determined by the setting of the **Quality** parameter.
- **CBR** = The encoder will operate in Constant Bit Rate mode. The encoder attempts to maintain a constant output bit rate by adjusting image quality as necessary. The bit rate will be determined by the setting of the **Bitrate** parameter.

(Setting the **Encoder Mode** to **CBR** can help you conserve bandwidth. When **CBR** is selected, you can set the **Bitrate** parameter to a low value and this will cause the camera to use less bandwidth. This is especially useful if you are operating a system with multiple cameras.)

Quality - If the **Encoder Mode** parameter is set to **VBR**, then the **Quality** parameter will determine the quality level of the images in the stream controlled by the currently selected tab. A higher setting means better quality.

Using higher quality settings will reduce the rate at which the camera can encode and stream images. Using lower quality settings will increase the rate.

Note that the effect of the quality setting is not precisely equivalent for each encoder type. For example, a quality setting of 50 will have a slightly different effect when the **Encoder Type** parameter is set to JPEG than it will have when it is set to MPEG4 or to H.264.

Bitrate - If the **Encoder Mode** parameter is set to **CBR**, then the **Bitrate** parameter sets the bit rate for the stream controlled by the currently selected tab.

Output Size - Lets you select from a list of standard image sizes. When you select a size, the camera checks the setting of the **Output Scaling** parameter. It then automatically sets the **Stream AOI Left**, **Stream AOI Top**, **Stream AOI Width**, and **Stream AOI Height** parameters so that the AOI will be centered on the sensor and set to the right width and height to result in output images of the size you selected.

Note that depending on the current setting of the **Output Scaling** parameter, some of the standard sizes shown below may not be listed. The sizes available in the list will vary depending on the camera model you are using, and the list will only include output sizes that can be achieved given the current **Output Scaling** parameter setting.

- **1024 x 768 (XGA)** = The size of the images in the stream will be 1024 x 768.
- **800 x 600 (SVA)** = The size of the images in the stream will be 800 x 600.
- **720 x 576 (D1 PAL)** = The size of the images in the stream will be 720 x 576.
- **720 x 480 (D1 NTSC)** = The size of the images in the stream will be 720 x 480.
- **704 x 576 (4CIF)** = The size of the images in the stream will be 704 x 576.
- **640 x 480 (VGA)** = The size of the images in the stream will be 640 x 480.
- **480 x 360** = The size of the images in the stream will be 480 x 360.
- **352 x 288 (CIF)** = The size of the images in the stream will be 352 x 288.
- **320 x 240 (QVGA)** = The size of the images in the stream will be 320 x 240.
- **176 x 144 (QCIF)** = The size of the images in the stream will be 176 x 144.
- **160 x 120 (QQVGA)** = The size of the images in the stream will be 160 x 120.
- **Auto** = the image size is non-standard. (Whenever you manually change the **Stream AOI Width** parameter or the **Stream AOI Height** parameter to a value that will not result in standard size image output, the value of the **Output Size** parameter will revert to "Auto").

Stream AOI Left - As shown in Figure 4 on [page 26](#), sets the left offset (in pixels) for the stream AOI, i.e., how far the stream AOI will be offset from the left edge of the image area captured by the camera's sensor. The setting must be a multiple of 8.*

Stream AOI Top - As shown in Figure 4 on [page 26](#), sets the top offset (in pixels) for the stream AOI, i.e., how far the stream AOI will be offset from the top edge of the image area captured by the camera's sensor. The setting must be a multiple of 2.*

Stream AOI Width - As shown in Figure 4 on [page 26](#), sets the width (in pixels) of the stream AOI. The setting must be a multiple of 8.*

Stream AOI Height - As shown in Figure 4 on [page 26](#), sets the height (in pixels) of the stream AOI. The setting must be a multiple of 8.*

* You can also use the **Stream AOI Editor** (see [page 33](#)) to set this parameter, and any changes you make to the AOI parameter settings on the **Stream** tab will be reflected on the **Stream AOI Editor**.

Output Scaling - Sets the amount that captured images will be rescaled before they are encoded and transmitted in the stream controlled by the currently selected tab.

- **1:1** = No rescaling.
- **1:2** = Rescale to 1/2 size.
- **1:4** = Rescale to 1/4 size.
- **1:8** = Rescale to 1/8 size.

Note that increasing the level of output scaling will decrease the workload on the processor in the camera. For more information about the effects of processor workload, see Section 3.1 on [page 7](#).

Frame Rate Scaling - Sets the ratio of captured images to encoded images.

- **1:1** = Every image captured by the camera's sensor will be encoded and streamed.
- **1:2** = Every second image captured by the camera's sensor will be encoded and streamed.
- **1:4** = Every fourth image captured by the camera's sensor will be encoded and streamed.
- **1:8** = Every eighth captured by the camera's sensor will be encoded and streamed.

Note that increasing the level of frame rate scaling will decrease the bandwidth used to stream images from the camera to a device.

GOP Length - If the **Encoder Type** parameter is set to MPEG4 or H.264, then the **GOP Length** parameter will set the time between I-frames in milliseconds.

In an MPEG4 or an H.264 stream, the camera transmits periodic I-frames and transmits several P-frames between each I-frame. I-frames carry complete information for a captured image. P-frames only carry information about the areas of the image that have changed since the last I-frame was transmitted. The time between the transmission of I-frames is determined by the **GOP Length** parameter. Increasing the time between I-frames (i.e., the GOP length) will increase the efficiency of the encoder. But be aware that increasing the GOP length also increases the latency

when you start an image stream because the decoder in the receiving device must wait longer for the initial I-frames.

Live Buffer Size - Sets the size (in kilobytes) of the live buffer for the stream controlled by the currently selected tab. The live buffer is a ring buffer that stores the last N captured images for the stream (N depends on the size of the images being encoded and the size of the buffer).

Alarm Buffer Size - Sets the size (in kilobytes) of the alarm buffer for the stream controlled by the currently selected tab. Normally, the alarm buffer is simply a ring buffer that stores the last N captured images for the stream (N depends on the size of the images being encoded and the size of the buffer). But when an alarm condition is declared, the alarm buffer will only continue to buffer post alarm images until the portion of the buffer that is allocated for post alarm image storage is full (see the next parameter). At that point, buffering will stop, and the pre and post alarm images held in the buffer will be retained until a new **Alarm Buffer Arm** command is issued (see Section 3.6.2 on [page 37](#)).

Post Alarm Buffer Size - Sets the portion of the alarm buffer (in kilobytes) that will be used for "post alarm" image storage. For example, if the **Alarm Buffer Size** parameter is set to 2048 kilobytes and the **Post Alarm Buffer Size** parameter is set to 1228 kilobytes, then 1228 kilobytes (i.e., 60%) of the alarm buffer will be allocated for holding post alarm images.

Text Overlay

Click the **Text Overlay** button to open the text overlay dialog box as shown below. The dialog box lets you define the text that will appear in a bar at the top or the bottom of each image transmitted in the stream controlled by the currently selected tab.

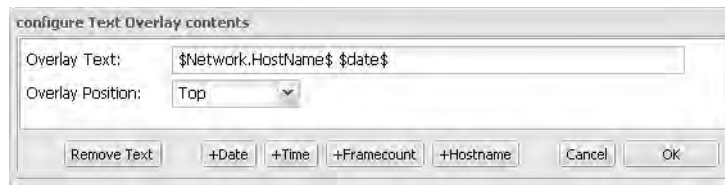





Overlay Text - Sets the text that will appear in the text overlay bar. You can enter simple strings of text, and you can also enter the following expressions:

\$date\$	= display the current date, time, and time zone (see Section 3.10.2 on page 53 to set the current date, time, and time zone and to set the date/time format).
\$timestamp\$	= display timestamp (sec:usec since 1970).
\$counter\$	= display frame counter.
\$motion\$	= display motion/no motion (no motion = blank space, motion = *).
\$motion_level\$	= display current motion level (number of changed pixels).
\$motion_level_0\$	= display current motion level (number of changed pixels).
\$frame_size\$	= display the width and height of the sensor AOI.
\$frame_position\$	= display the left offset and top offset for the sensor AOI.
\$alarm\$	= display if an alarm condition has been declared (no alarm = blank space, alarm = *).
\$alarm_nr\$	= display alarm number (if any).
\$fps\$	= display the current frame rate for this stream.
\$\$SysInfo.ModelName\$	= display the camera's model name.
\$\$SysInfo.FirmwareVersion\$	= display the camera's firmware version info.
\$\$SysInfo.ManName\$	= display the camera vendor's name.
\$\$SysInfo.Serial\$	= display the camera's serial number.
\$\$SysInfo.MACAddress\$	= display the camera's MAC address.
\$\$System.DateTimeFormat\$	= display the current date/time format setting.
\$Network.RxTraffic\$	= display the current incoming network traffic level in kilobits/s.
\$Network.TxTraffic\$	= display the current outgoing network traffic level in kilobits/s.
\$Network.HostName.	= display the host name of the camera.

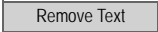
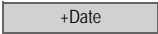
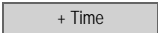
Overlay Position - Sets the position of the text overlay bar.

- **Top** = Place the text overlay bar at the top of each streamed image.
- **Bottom** = Place the text bar at the bottom of each image.

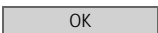
	Click the Remove Text button to clear all of the text from the Overlay Text line.
	Click the + Date button to quickly enter the \$date\$ expression into the Overlay Text line.
	Click the + Time button to quickly enter the \$timestamp\$ expression into the Overlay Text line.
	Click the + Framecount button to quickly enter the \$counter\$ expression into the Overlay Text line.
	Click the + Hostname button to quickly enter the \$Network.HostName\$ expression into the Overlay Text line.
	Click the Cancel button to cancel all of the changes you have made and close the text overlay dialog box.
	Click the OK button to save all of the changes you have made and close the text overlay dialog box.

Stream AOI Editor - Whenever a stream tab is selected, a **Stream AOI Editor** screen will also be available as shown below.



Rather than setting numbers in the boxes on the stream tab, you can use the editor to set the AOI size and position for the stream controlled by the currently selected tab. To set the stream AOI with the editor, simply use your cursor to drag the edges of the red rectangle that represents the stream AOI. You can also use the buttons at the bottom of the editor to set the stream AOI to the full size of the sensor AOI, to set the stream AOI to 1/4 of the sensor AOI's size, to align the stream AOI to the top left side of the sensor AOI, or to center the stream AOI within the sensor AOI.

When you are working with a stream AOI, remember that the stream AOI must be contained within the sensor AOI. So if you have changed the size or the position of the sensor AOI, this will restrict what you can do with the stream AOI.

Note that the dotted yellow rectangle in the **Stream AOI Editor** shows the current size and position of the sensor AOI.



A stream AOI must be contained within the sensor AOI (see Section 3.4.1 on [page 19](#), Figure 3 on [page 19](#), and Figure 4 on [page 26](#)). So if you have decreased the size of the sensor AOI, you will find that the allowed settings for the stream AOIs will be restricted.

3.5 Motion Detection Parameters

The parameters in the **Motion Detection** group are used to control the operation of the camera's motion detection function.

To understand what the parameters in this group do, you should have a basic idea about how motion detection works:

Just before the camera captures a new image, it takes the last few captured images (from its memory) and uses them to create an averaged image called a "history image".

Immediately after the camera captures a new image, it compares the pixels in the newly captured image with the pixels in the history image. If enough pixels have changed, the camera will determine that motion has been detected.

(When motion detection is enabled, this history image creation/comparison process occurs for each image captured.)

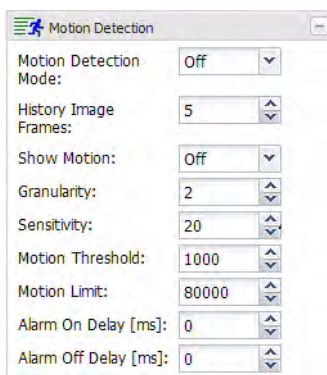

Motion Detection Mode - Enables or disables motion detection.

- **Off** = Motion detection disabled.
- **On** = Motion detection enabled.

History Image Frames - Sets the number of previously captured images that will be used to create the history image. For example, if this value is set to 3, the last 3 captured images will be used to create the history image.

Higher values give better motion detection performance, but they also slow down the speed of the motion detection algorithm and put a greater load on the camera's microprocessor.

Show Motion - Enables or disables the show motion function.

- **Off** = Show motion function disabled.
- **On** = Show motion function enabled. The live image streams displayed in the web client will show any pixels where motion is detected in green.

Granularity - Sets which pixels in the current image will be compared to the history image. **1** means that every pixel will be compared, **2** means that every second pixel will be compared, **3** means that every third pixel will be compared, and so on.

Raising the granularity will speed-up the motion detection algorithm and reduce the load on the microprocessor, but increasing it too much means that movement by small objects may be missed.

Sensitivity - Sets the percentage of difference that must be present between a pixel in the current image and the corresponding pixel in the history image for a change in the pixel to be detected. **1** means that the pixels must be 1% different to detect a change, **2** means that they must be 2% different, and so on. **With this scheme, a higher setting means less sensitivity.**

Motion Threshold - Sets a threshold for motion detection. If the number of changed pixels in the current image is above the motion threshold and below the motion limit (see the next parameter), then motion will be detected.

Motion Limit - Sets a limit for motion detection. If the number of changed pixels in the current image is above the motion threshold (see the previous parameter) and below the motion limit, then motion will be detected.

Alarm On Delay - Sets the amount of time (in milliseconds) that continuous motion must be detected in order to declare a motion alarm condition.

Alarm Off Delay - Sets the amount of time (in milliseconds) that no motion must be detected in order to end a motion alarm condition.

3.6 Alarm Handling Parameters

The parameters in the **Alarm Handling** group are used to select the sources that can declare an alarm condition and to control the actions that will be taken when an alarm condition is declared.

3.6.1 Alarm Sources Section

The alarm sources section of the alarm handling parameters group is used to select the sources that can declare an alarm condition.

User Trigger Tab

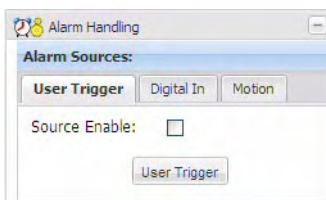

Source Enable - Check the **Source Enable** box on the **User Trigger** tab to enable the user trigger as a source for declaring an alarm condition.

User Trigger

If the user trigger is enabled as an alarm source, you can click the **User Trigger** button to declare an alarm condition.

Digital In Tab

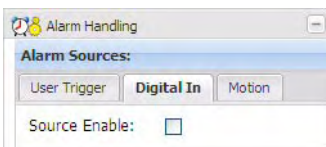

Source Enable - Check the **Source Enable** box on the **Digital In** tab to enable the camera's digital input line as a source for declaring an alarm condition.

If the digital input line is enabled as an alarm source and the line becomes active, an alarm condition will be declared.

Motion Tab

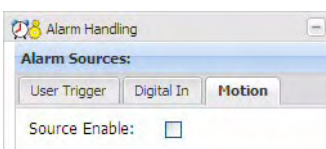

Source Enable - Check the **Source Enable** box on the **Motion** tab to enable motion detection as a source for declaring an alarm condition.

If motion detection is enabled as an alarm source and motion is detected, an alarm condition will be declared.

(In order to use motion detection as an alarm source, motion detection must be enabled. See Section 3.5 on [page 34](#) for more information about motion detection.)

3.6.2 Alarm Buffers Section

Each video stream can have an alarm buffer. Normally, the alarm buffer on a stream is a simply a ring buffer that stores the last N captured images for the stream (N depends on the size of the images being encoded and the size of the buffer). If an alarm condition is declared, however, the alarm buffer will only continue to buffer post alarm images until the part of the buffer that is allocated for post alarm buffering is full. At that point, buffering will stop, and the pre and post alarm images held in the buffer will be retained until a new **Alarm Buffer Arm** command is issued.

Note that you will only be allowed to arm the alarm buffer if the **Alarm Buffer Size** and **Post Alarm Buffer Size** parameters for the stream have been set to values greater than zero (see [page 30](#)).

Stream 0 Tab



Alarm Buffer State - Indicates the current state of the alarm buffer for stream 0.

- **Off** = The buffer is disabled.
- **Arming** = The buffer is in the process of being armed.
- **Armed** = The buffer is armed and ready to react to an alarm condition.
- **Active** = An alarm condition has been declared and the buffer is actively buffering post alarm images.
- **Done** = The buffer has finished buffering post alarm images and has stopped buffering.

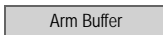

Click the **Arm Buffer** button to arm the alarm buffer for stream 0. (If the buffer is in a "done" state, this will arm the buffer and make it begin buffering again.)



Click the **Disable Buffer** button to disable the alarm buffer for stream 0.

Stream 1 Tab and Stream 2 Tab

The contents and operation of the **Stream 1** tab and the **Stream 2** tab are similar to the **Stream 0** tab.

3.6.3 Alarm Actions Section

The alarm actions section of the alarm handling parameters is used to control the actions that will be taken when an alarm condition is declared.

Digital Output Tab

The screenshot shows the 'Alarm Actions' window with the 'Digital Output' tab selected. It contains the following fields:

- Action Enable:**
- Digital Output Hold Time [ms]:** 1000

Action Enable - Check the **Action Enable** box on the **Digital Output** tab to enable the camera's digital output line as an action to take when an alarm condition is declared. If the digital output line is enabled as alarm action, it will become active when an alarm condition is declared.

Digital Output Hold Time - Sets the amount of time (in milliseconds) that the output line will remain active after an alarm condition is declared.

Note that if the hold time is set to 0, the output line will remain active only as long as the alarm condition remains active.

Email Tab

The screenshot shows the 'Alarm Actions' window with the 'Email' tab selected. It contains the following fields and controls:

- Action Enable:**
- Include Image:**
- Text Overlay:**
- Email:**
- Email Server:**
- Email Port:** 25
- Email User Name:**
- Email Password:**
- Email From:** camera@\$hostname

Action Enable - Check the **Action Enable** box on the **Email** tab to enable the sending of an email as an action to take when an alarm condition is declared.

Include Image - Check the **Include Image** box to include an image with the email. The included image will be in JPEG format and will be an image that was captured when the alarm was declared. The image will be the size of the sensor AOI (see Section 3.4.1 on [page 19](#)).

Click the **Text Overlay** button to add a text overlay to the image included with the email. See [page 40](#) and [page 41](#) for an explanation of how to use the **Text Overlay** button.

Email - Enter an email address for the recipient of the email.

Email Server - Enter an address for the SMTP server that will be used to send the email.

Email Port - Select a port to use on the target email server.

Email User Name - Enter a user name for authentication on the SMTP server. Up to 15 numbers and/or letters (upper or lower case) can be used.

Email Password - Enter a password for authentication on the SMTP server. Up to 29 characters can be used. All standard keyboard characters are valid.

Email From - Enter an email address to appear as the sender's address in the email sent by the camera. You can use the variable \$hostname\$ as part of the address, and the variable will be replaced with the camera's actual host name.

HTTP Tab

Action Enable - Check the **Action Enable** box on the **HTTP** tab to enable the sending of an HTTP request as an action to take when an alarm condition is declared.

HTTP URL - Enter a valid URL request. You could, for example, enter this request: `http://MyServer/cgi-bin/alarm.cgi`

You should be aware that the camera will automatically add the following two parameters to the end of the request:

`?host=<hostname>&date=<date/time>`

where the hostname is the camera's host name and the date/time is the current date and time.

FTP Tab

Action Enable - Check the **Action Enable** box on the **FTP** tab to enable the sending of an FTP upload as an action to take when an alarm condition is declared. The upload will be a text file that includes information such as the camera host name and the date and time.

Include Image - Check the **Include Image** box to include an image with the FTP upload. The included image will be a separate JPEG file and will be an image that was captured when the alarm was declared. The image will be the size of the sensor AOI (see Section 3.4.1 on [page 19](#)).

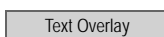

Click the **Text Overlay** button to add a text overlay to the image included with the FTP upload. See [page 40](#) and [page 41](#) for an explanation of how to use the **Text Overlay** button.

FTP Server - Enter a valid address for the FTP server that will receive the upload.

FTP Port - Select the port to use on the target FTP server.

FTP Remote Dir - Enter the path to a target subdirectory for the FTP upload. (If no path is specified, the root directory will be used.)

FTP User Name - Enter a user name for authentication on the FTP server. Up to 15 numbers and/or letters (upper or lower case) can be used.

FTP Password - Enter a password for authentication on the FTP server. Up to 29 characters can be used. All standard keyboard characters are valid.

Text Overlay

Click the **Text Overlay** button to open the text overlay dialog box as shown below. The dialog box lets you define the text that will appear in a bar at the top or the bottom of the image included with the email or FTP upload.

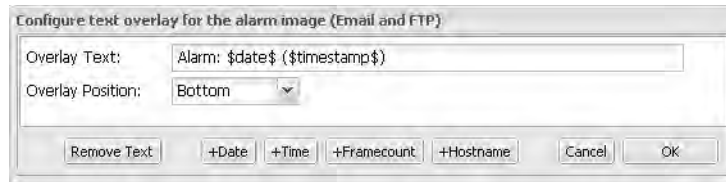

Overlay Text - Sets the text that will appear in the text overlay bar. You can enter simple strings of text, and you can enter the following expressions:

\$date\$	= display the current date, time, and time zone (see Section 3.10.2 on page 53 to set the current date, time, and time zone and to set the date/time format).
\$timestamp\$	= display timestamp (sec:usec since 1970).
\$counter\$	= display frame counter.
\$motion\$	= display motion/no motion (no motion = blank space, motion = *).
\$motion_level\$	= display current motion level (number of changed pixels).
\$motion_level_0\$	= display current motion level (number of changed pixels).
\$frame_size\$	= display the width and height of the sensor AOI.
\$frame_position\$	= display the left offset and top offset for the sensor AOI.
\$alarm\$	= display if an alarm condition has been declared (no alarm = blank space, alarm = *).
\$alarm_nr\$	= display alarm number (if any).
\$SysInfo.ModelName\$	= display the camera's model name.
\$SysInfo.FirmwareVersion\$	= display the camera's firmware version info.
\$SysInfo.ManName\$	= display the camera vendor's name.
\$SysInfo.Serial\$	= display the camera's serial number.
\$SysInfo.MACAddress\$	= display the camera's MAC address.
\$System.DateTimeFormat\$	= display the current date/time format setting.
\$Network.RxTraffic\$	= display the current incoming network traffic level in kilobits/s.
\$Network.TxTraffic\$	= display the current outgoing network traffic level in kilobits/s.
\$Network.HostName.	= display the host name of the camera.

Overlay Position - Sets the position of the text overlay bar.

- **Top** = Place the text overlay bar at the top of each streamed image.
- **Bottom** = Place the text bar at the bottom of each image.

Remove Text

Click the **Remove Text** button to clear all of the text from the **Overlay Text** line.

+Date

Click the + **Date** button to quickly enter the `$date$` expression into the **Overlay Text** line.

+ Time

Click the + **Time** button to quickly enter the `$timestamp$` expression into the **Overlay Text** line.

+ Framecount

Click the + **Framecount** button to quickly enter the `$counter$` expression into the **Overlay Text** line.

+ Hostname

Click the + **Hostname** button to quickly enter the `$Network.HostName$` expression into the **Overlay Text** line.

Cancel

Click the **Cancel** button to cancel all of the changes you have made and close the text overlay dialog box.

OK

Click the **OK** button to save all of the changes you have made and close the text overlay dialog box.

3.7 Network Parameters

The parameters in the **Network** group are used to set the camera's IP configuration.

3.7.1 Settings Tab

The screenshot shows a web interface window titled 'Network'. It has four tabs: 'Settings', 'RTSP', 'QoS', and 'I/O'. The 'Settings' tab is active. The following fields are visible:

- Host Name: Basler-20900870
- DHCP:
- IP Address: 172.17.1.23
- Network Prefix: 24
- Name Server: 172.17.1.10 172.1
- Gateway: 172.17.1.1
- HTTP Port: 80

At the bottom of the window are two buttons: 'Commit' and 'Revert'.

Host Name - Assigns a host name to the camera. Only letters, digits, and dashes are allowed. No spaces or periods are allowed. (If DHCP addressing is enabled, the host name may be overwritten by the DHCP server.)

DHCP - Check the **DHCP** box to enable camera IP addressing via a DHCP server. Note that if this box is checked, the other parameters on the tab will be grayed out.

IP Address - Assigns an IP address to the camera that will be used if DHCP addressing is disabled.

Network Prefix - If DHCP is disabled, specifies the number of bits which represent the netmask for your network. For example: 16 = 255.255.0.0 or 24 = 255.255.255.0

Name Server - Sets the name server that the camera will use if DHCP is disabled.

Gateway - Sets the network gateway that the camera will use if DHCP is disabled.

HTTP Port - Sets the HTTP port on which the web interface will listen.



Click the **Commit** button save any changes you have made to the network settings.



Click the **Revert** button to cancel any changes you have made to the network settings. The settings will revert to what they were the last time that the **Commit** button was clicked.

3.7.2 RTSP Tab

The screenshot shows a 'Network' configuration window with tabs for 'Settings', 'RTSP', 'QoS', and 'I/O'. The 'RTSP' tab is active. It contains the following settings:

- Enabled:**
- RTSP Port:** 554
- Multicast:**
- Multicast On-Demand:**
- Multicast IP:** 225.0.0.101
- Multicast Port:** 60000
- Multicast TTL:** 255

At the bottom of the window are two buttons: 'Commit' and 'Revert'.

Enabled - Check the **Enabled** box to enable the Real Time Streaming Protocol (RTSP). RTSP is a control protocol that allows the camera to negotiate which transport protocol to use for the video streams. Typically, RTSP streaming should be enabled.

RTSP Port - Sets the port that will be used by RTSP. The default port is 554.

Multicast - Check the **Multicast** box to enable multicast streaming. Multicasting is a bandwidth conserving technology. It reduces bandwidth by allowing the camera to deliver a single video stream to multiple recipients on the network. Note that multicasting will only work for streams where the **Encoder Type** parameter (see Section 3.4.2 on [page 26](#)) is set to MPEG4 or to H264.

Multicast On-Demand - Check the **Multicast On-Demand** box to make the multicast stream an "on-demand" stream. When multicast streaming on-demand is enabled, the camera will only deliver a multicast video stream when one or more devices are requesting the multicast stream. This is an additional bandwidth reducing mechanism.

Multicast IP - If multicast streaming is enabled, sets the IP address for multicast streaming. The Multicast IP address must be in the range from 224.0.1.0 to 239.255.255.255.

Multicast Port - If multicast streaming is enabled, sets the port for multicast streaming.

Multicast TTL - If multicast streaming is enabled, sets the multicast Time-To-Live (TTL). The multicast Time-To-Live (TTL) value specifies the number of routers (hops) that multicast traffic is permitted to pass through before expiring on the network.



Click the **Commit** button save any changes you have made to the RTSP settings.



Click the **Revert** button to cancel any changes you have made to the RTSP settings. The settings will revert to what they were the last time that the **Commit** button was clicked.

3.7.3 QoS Tab

The parameters on this tab are used to set network traffic prioritization settings, commonly known as QoS or Quality of Service settings. Note that these settings will only have an effect on networks where all network switches and routers support QoS.

Normally, these settings should only be adjusted by a network administrator.

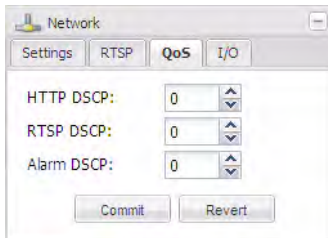

HTTP DSCP - Sets the HTTP DSCP (differentiated services code point) value.

RTSP DSCP - Sets the RTSP DSCP (differentiated services code point) value.

Alarm DSCP - Sets the alarm DSCP (differentiated services code point) value.

Commit

Click the **Commit** button save any changes you have made to the QoS settings.

Revert

Click the **Revert** button to cancel any changes you have made to the QoS settings. The settings will revert to what they were the last time that the **Commit** button was clicked.

3.7.4 Network I/O Tab

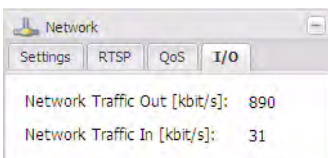

Network Traffic Out - Indicates the current amount of outgoing network traffic in kilobits per second.

Network Traffic In - Indicates the current amount of incoming network traffic in kilobits per second.

3.8 Input / Output Parameters

The parameters in the **Input/Output** group are used to work with the camera's digital input and output pins and to configure the camera's RS-232 serial port.

3.8.1 Digital I/O Tab

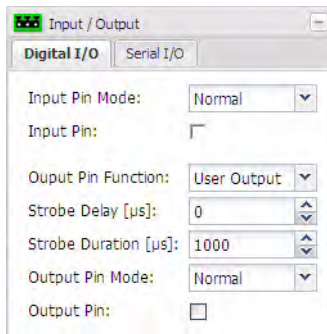

Input Pin Mode - Sets whether the active/inactive state of the input pin will operate normally or be inverted.

- **Normal** = The input pin will operate normally.
- **Inverted** = The operation of the input pin will be inverted.

See Table 3 on [page 66](#) for details about normal and inverted input pin operation.

Input Pin - Indicates the state of the camera's digital input pin. If the box is unchecked, the input is inactive. If the box is checked, the input is active.

Output Pin Function - sets the functionality of output pin 0 on the camera.

- **User Output** = The output pin state is user settable. You can set the state of the output pin by using the **Output Pin** check box (see below).
- **IR Filter Announce** = The camera will announce the position of the IR-cut filter by setting the state of output pin 0. See Section 6 on [page 71](#) for details about the IR-cut filter and the announce feature.
- **Strobe** = The camera will output a pulse on output pin 0 that is synchronized to the start of each image capture. This signal is useful for controlling things such as a strobe exposure lamp. The **Strobe Delay** and **Strobe Duration** parameters (see below) are used to adjust the characteristics of the strobe pulse.

Strobe Delay - If the **Output Pin Function** is set to **Strobe** (see above), the **Strobe Delay** parameter sets a delay time (in microseconds) between when image capture starts and when the strobe pulse becomes active.

Strobe Duration - If the **Output Pin Function** is set to **Strobe** (see above), the **Strobe Duration** parameter sets the length of time (in microseconds) that the strobe pulse will remain active.

Output Pin Mode - sets whether the active/inactive state of the output pin will operate normally or be inverted.

- **Normal** = The output pin will operate normally.
- **Inverted** = The operation of the output pin will be inverted.

See Table 3 on [page 66](#) for details about normal and inverted output pin operation.



If the output pin has been set to the inverted mode and you restart the camera or you power it off and back on, the output will be in the normal mode during the camera bootup process and will return to the inverted mode once the bootup process is complete.

Output Pin - Indicates the state of the camera's digital output pin. If the box is unchecked, the output is inactive. If the box is checked, the output is active.

If the **Output Pin Function** parameter is set to "User Output", you can also use the box to set the state of the output. Check the box to make the output active, and uncheck the box to make the output inactive.

3.8.2 Serial I/O Tab

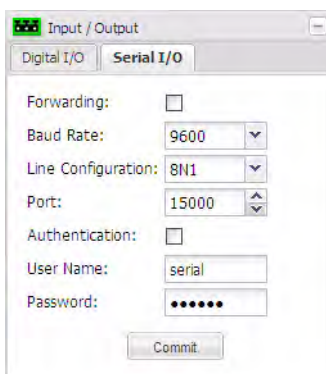

The screenshot shows the 'Input / Output' configuration window with the 'Serial I/O' tab selected. The 'Forwarding' checkbox is unchecked. The 'Baud Rate' is set to 9600, 'Line Configuration' is 8N1, and 'Port' is 15000. The 'Authentication' checkbox is unchecked, and the 'User Name' is 'serial'. The 'Password' field is masked with dots. A 'Commit' button is at the bottom.

Forwarding - Check the **Forwarding** box to enable serial port forwarding. When forwarding is enabled, serial commands issued via TCP/IP over the designated port (see the **Port** parameter below) will be forwarded to the serial port.

Baud Rate - Sets the baud rate for the serial port (in bits per second).

Line Configuration - Sets the line configuration for the serial port in Data Bits, Parity, Stop Bit format. For example, **8N1** means 8 data bits, no parity, 1 stop bit.

Port - Sets the port to listen to for incoming TCP/IP traffic. If forwarding is enabled, all traffic will be forwarded to the serial port.

Authentication - If the **Authentication** box is checked, then a login will be required to access the serial port.

User Name - Sets the user name for access to the serial port. Up to 15 numbers and/or letters (upper or lower case) can be used.

Password - Sets the password for access to the serial port. Up to 29 characters can be used. All standard keyboard characters are valid.

Commit

Click the **Commit** button save any changes you have made to the settings.

3.9 User Parameters

The parameters in the **User** group are used to manage user authentication on the camera.

3.9.1 Enabling Authentication and Logging in for the First Time

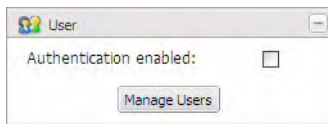

Authentication enabled - Check the **Authentication enabled** box to enable user authentication on the camera. With user authentication enabled, a valid user name and password will be required to access the camera.

When you check the **Authentication enabled** box, you will see a warning window similar to the one shown below. Click **Yes** to enable authentication.

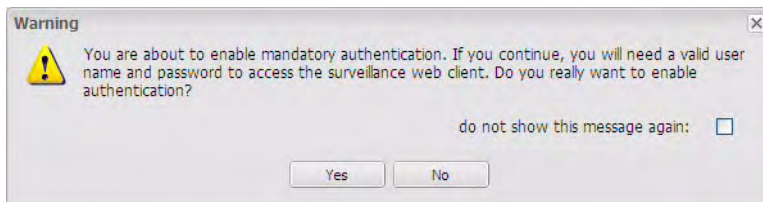

User authentication will become enabled, and a Please Login window will appear as shown below.

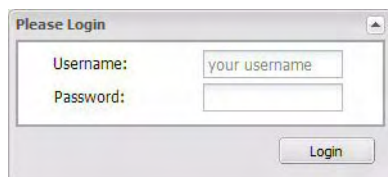

You can log in for the first time by using the default administrator user name and password (case sensitive):

Username: admin

Password: admin



To disable user authentication, make sure that you have logged in as an administrator and simply uncheck the **Authentication enabled** box.

3.9.2 Logging Out and Logging In

Once you have logged into the camera, a **Logged in:** indicator, a **Change Password** button, and a **Logout** button (shown circled in red below) will appear in the Basler tool bar.

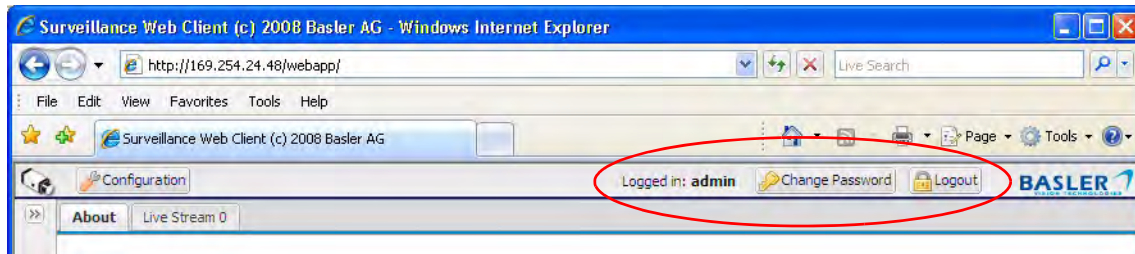

Notice that the **Logged in:** indicator displays the user name of the person who is currently logged into the camera (in this case, the user is named "admin").

Click the **Change Password** button to change the password of the person who is currently logged into the computer. When you click the button, a **User Editor** window will appear as shown below. Enter a valid password, reenter the password to verify, and click the **Save** button.

User names and passwords can include letters, numbers, and underscores (_). **User names and passwords are case sensitive.**

To log out, simply click the **Logout** button. When you log out, the web browser will gray, and a **Please Login** window will appear as shown below.

To log back in, enter a valid user name and password, and then click the **Login** button.



If you are logged into the camera, refreshing the browser or closing the browser window will not log you out. You will remain logged in until you follow the log out procedure or restart the camera.

3.9.3 Managing Users

To manage users, you must be logged into the camera as an administrator.

Once you are logged in, access the **User** parameters group, and click on the **Manage Users** button. A **Manage Users** tab will appear as shown below.

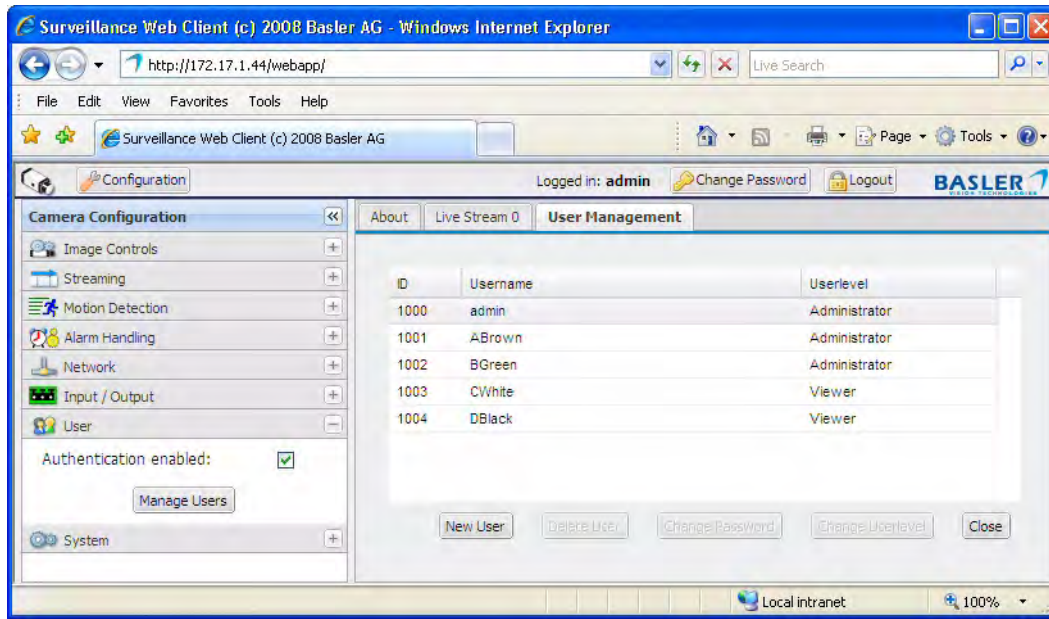

User names can include letters, numbers, and underscores (_). **User names and passwords are case sensitive.**

The available user levels are described in Table 1.

User Level	Meaning
Administrator	Can change all camera configuration parameters. Can add or delete users. Can change the level or password of all existing users.
Viewer	Can view images and can change his or her own password. Has no access to camera parameters.

Table 1: Available User Levels

To Add a New User

1. Click the **New User** button on the **Manage Users** tab. A **User Editor** window will appear as shown below.

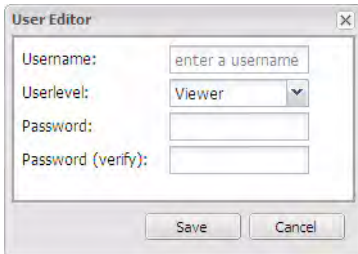

The User Editor dialog box contains the following fields and controls:

- Username:** A text input field with the placeholder text "enter a username".
- Userlevel:** A dropdown menu currently set to "Viewer".
- Password:** A text input field.
- Password (verify):** A text input field.
- Buttons:** "Save" and "Cancel" buttons at the bottom.

2. Enter a user name, select a user level (see Section Table 1: on [page 49](#)), enter a password, reenter the password to verify, and click the **Save** button.
3. A **Success** message window will open. Click the **OK** button.

To Delete an Existing User

1. In the **Manage Users** tab, click on the name of the user you wish to delete. As shown below, the user information will become highlighted, and the **Delete User** button will become ungrayed.

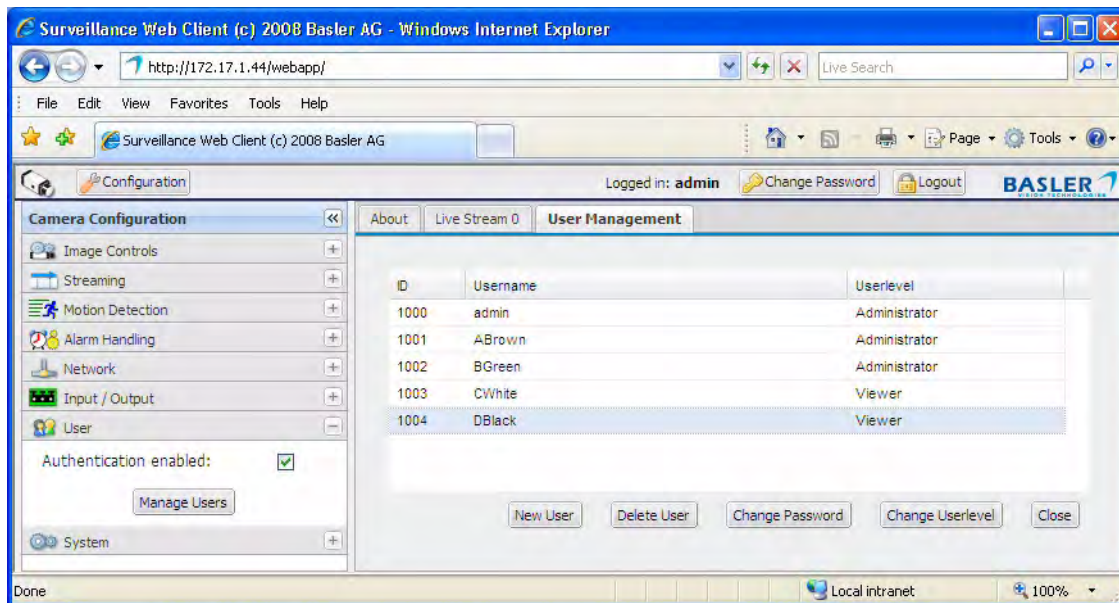

2. Click the **Delete User** button.
3. An **Are you sure** message window will open. Click the **Yes** button.
4. A **Success** message window will open. Click the **OK** button.



You must have at least one administrator level user. If there is only one administrator level user, you will not be able to delete that user.

To Change an Existing User's Password

1. In the **Manage Users** tab, click on the name of the user whose password you wish to change. As shown below, the user information will become highlighted, and the **Change Password** button will become ungrayed.

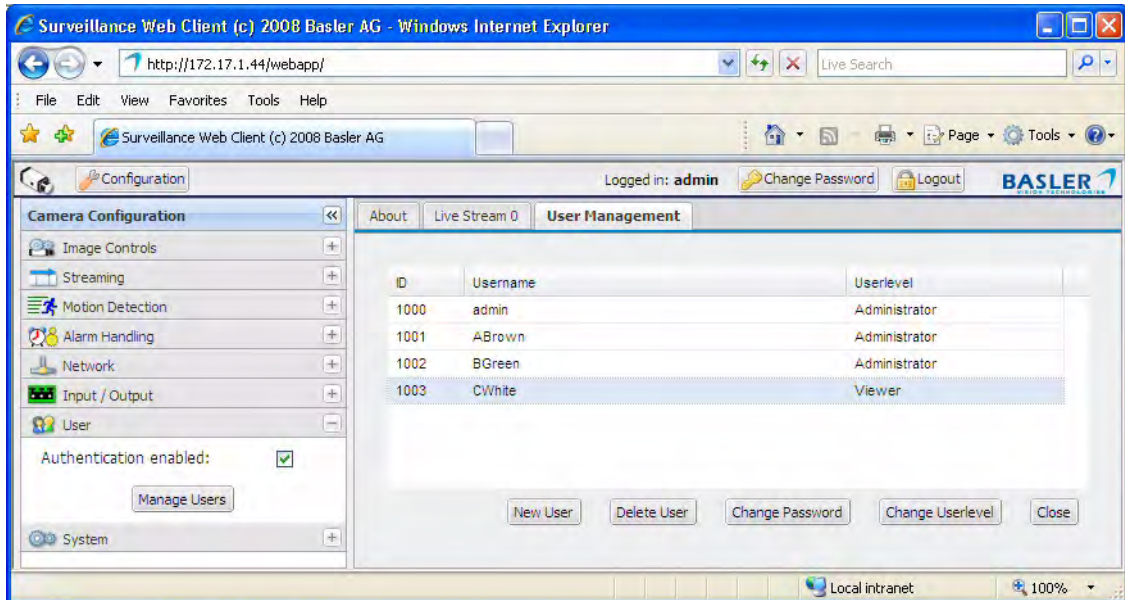

2. Click the **Change Password** button. A **User Editor** window will appear as shown below.

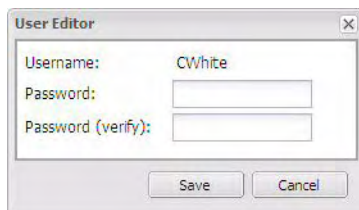

3. Enter a new password, reenter the password to verify, and click the **Save** button.

To Change an Existing User's User Level

1. In the **Manage Users** tab, click on the name of the user whose user level you wish to change (see Section Table 1: on [page 49](#) for user level descriptions). As shown below, the user information will become highlighted, and the **Change User-Level** button will become ungrayed.

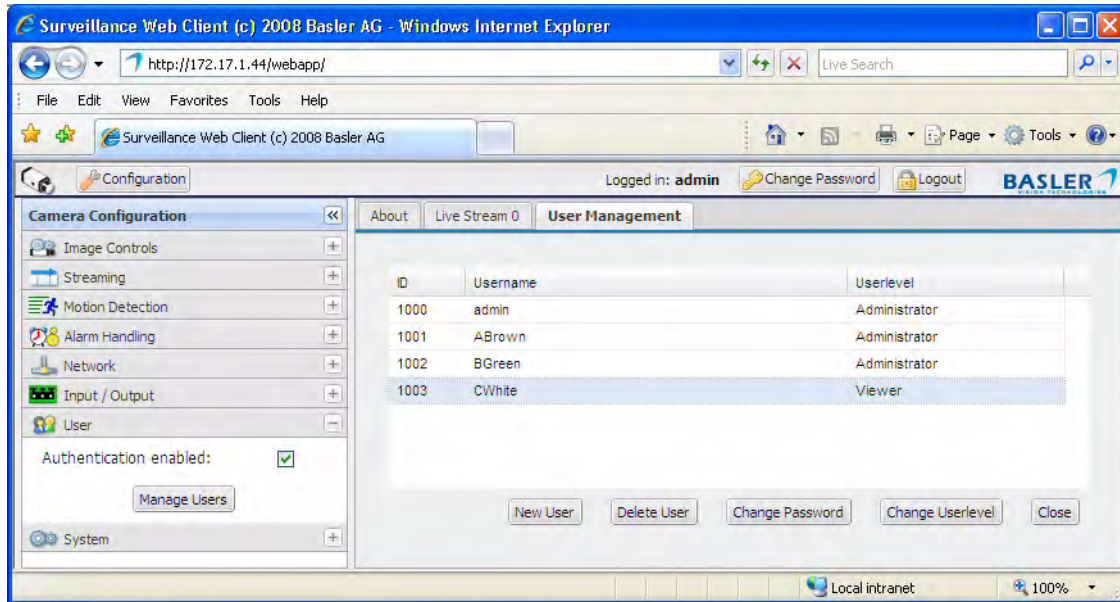

2. Click the **Change User-Level** button. A **User Editor** window will appear as shown below.

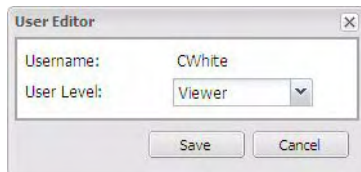

3. Select a new user level from the drop down menu, and click the **Save** button.



You must have at least one administrator level user. If there is only one administrator level user, you will not be able to change that user's user level.

3.10 System Parameters

The parameters in the **System** group provide some basic information about the camera and allow you to set basic system characteristics such as the date and time.

3.10.1 Info Tab

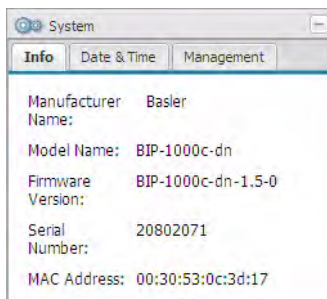

Manufacturer Name - Indicates the name of the camera's manufacturer.

Model Name - Indicates the camera's model name.

Firmware Version - Indicates the version number of the firmware currently installed in the camera.

Serial Number - Indicates the camera's serial number.

MAC Address - Indicates the camera's MAC address.

3.10.2 Date & Time Tab

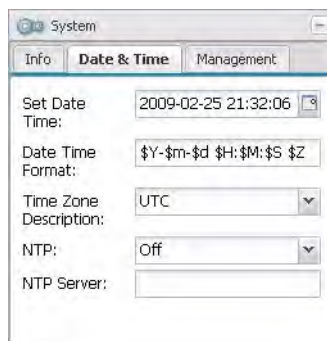

Set Date Time - Sets the date and time that will appear in the text overlay on streamed images (see Section 3.4.2 on [page 26](#) for more information about the text overlay). Click the  button to display a calendar that will let you easily set the date and time. The time is set based on a 24 hour clock.

Date Time Format - Sets the format for the date, time, time zone entry that will appear in the text overlay on streamed images.

The following symbols can be entered in the Date Time Format box:

- \$d = display the day of the month as a decimal number (i.e., from 01 to 31).
- \$D = same as entering \$m/\$d/\$y.
- \$F = same as entering \$Y-\$m-\$d.
- \$h = display the abbreviated month name.
- \$H = display the hour as a decimal number using a 24-hour clock (i.e., from 00 to 23).

- \$l = display the hour as a decimal number using a 12-hour clock (i.e., from 01 to 12).
- \$m = display the month as a decimal number (i.e., from 01 to 12).
- \$M = display the minute as a decimal number.
- \$r = display the time in a.m. and p.m. notation.
- \$R = display the time in 24 hour notation.
- \$S = display the seconds as a decimal number.
- \$T = display the current time, same as entering \$H:\$M:\$S.
- \$y = display the year without the century as a decimal number.
- \$Y = display the year as a decimal number.
- \$Z = display the time zone code if available.

Time Zone Description - Sets the time zone. See Table 2 on [page 55](#) for a list of locations that correspond to the time zone codes shown in the drop down list.

NTP - Enables or disables clock synchronization with an NTP server.

- **Off** = NTP synchronization is disabled.
- **1 hour** = NTP synchronization is enabled and updates occur once every 1 hour.
- **2 hours** = NTP synchronization is enabled and updates occur once every 2 hours.
- **4 hours** = NTP synchronization is enabled and updates occur once every 4 hour.s
- **12 hours** = NTP synchronization is enabled and updates occur once every 12 hours.
- **24 hours** = NTP synchronization is enabled and updates occur once every 24 hours.
- **Weekly** = NTP synchronization is enabled and updates occur once per week.

NTP Server - Sets the IP Address or name of the NTP server to use when NTP synchronization is enabled.

Time Zone Code	Location
Coordinated Universal Time	London, England
Asia, Iran (Summer) Time	Tehran, Iran
Asia, Indian Standard Time	New Delhi, India
Asia, Indochina Time	Jakarta, Indonesia
Asia, China Standard Time	Beijing, China
Asia, Japan/Korea Standard Time	Tokyo, Japan
Australia, Australian Western Standard/Daylight Time	Perth, Australia
Australia, Central Standard/Daylight Time	Adelaide, Australia
Australia, Central Standard Time	Darwin, Australia
Australia, Australian Eastern Standard/Daylight Time ⁰	Hobart, Australia
Australia, Australian Eastern Standard Time	Brisbane, Australia
Australia, New Zealand Standard/Daylight Time	Auckland, New Zealand
Europe, West European (Summer) Time	Lisbon, Portugal
Europe, Central European (Summer) Time	Geneva, Switzerland
Europe, East European (Summer) Time	Helsinki, Finland
Europe, Moscow (Daylight) Time	Moscow, Russia
North America, Alaska Standard/Daylight Time	Alaska Time, USA
North America, Atlantic Standard/Daylight Time	Atlantic Time, Canada
North America, Central Standard/Daylight Time	Central Time, USA
North America, Eastern Standard / Daylight Time	Eastern Time, USA
North America, Hawaii Time	Hawaii Time, USA
North America, Mountain Standard/Daylight Time	Mountain Time, USA
North America, Mountain Standard Time	Mountain Time (Arizona), USA
North America, Newfoundland Standard/Daylight Time	Newfoundland Time, Canada
North America, Pacific Standard/Daylight Time	Pacific Time, USA
South America, Argentina	Buenos Aires, Argentina
South America, Brazil	São Paulo, Brazil
South America, Central America	Tegucigalpa, Honduras
South America, Columbia	Bogota, Columbia

Table 2: Time Zone Codes and Locations

3.10.3 Management Tab

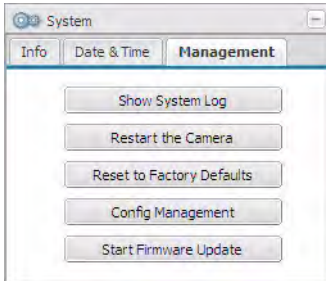

Show System Log

Click the **Show System Log** button to display a log of system messages.

Restart the Camera

Click the **Restart the Camera** button to reboot the camera. When the reboot is complete, the web client will reopen in your browser. Restarting your camera will not change any parameter settings

Reset to Factory Defaults

Click the **Reset to Factory Defaults** button to reset the camera to factory defaults. Before using this button, be absolutely sure that this is what you want to do.

After you click the **Reset to Factory Defaults** button, you will see an **Are you sure?** message as shown below:

- If the **Keep Network/User Settings** check box is checked, the camera will reset all of the configuration settings except the network settings and the user settings.
- If the **Keep Network/User Settings** check box is cleared, the camera will reset all of the configuration settings including the network settings and the user settings.

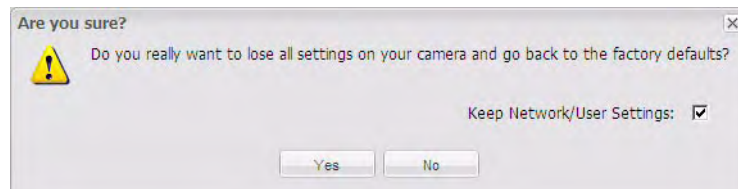

Depending on how your network is configured, if you reset the network settings, you may not be able to access the camera via your web browser after you do the reset. If this is the case, use the BIP Finder software to connect to the camera as described in the Basler IP Camera Installation Guide.

Config Management

Use the **Config Management** button to save the camera's current parameter settings to a file on your PC or to upload a saved configuration file from your PC to the camera.

To save the current parameter settings to a configuration file on your PC:

1. Click the **Config Management** button.
2. A **Configuration Management** dialog box will open as shown below. Click the **Download Config** button in the dialog box.

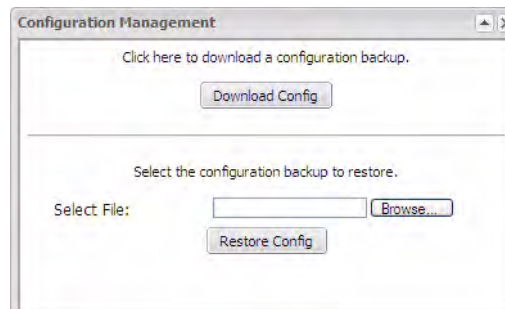

3. A **File Download** window will open as shown below. Click the **Save** button in the dialog box.



4. A **Save As** dialog box will open as shown below. Select a location where the file will be saved, enter a file name (we recommend using .cfg as the file name extension), and click the **Save** button.

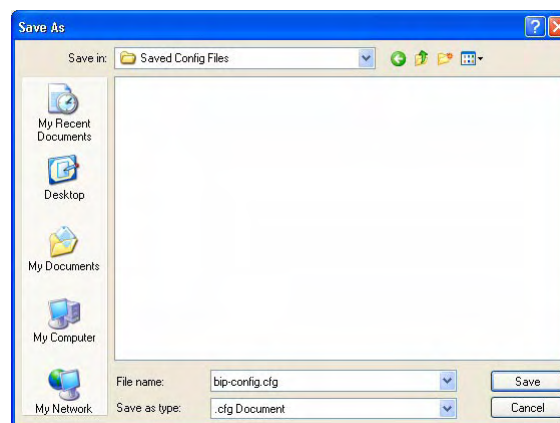

5. When the **Download Complete** screen appears, click the **Close** button.
6. Click the **Close** button in the **Configuration Management** dialog box.

To upload a saved configuration file on your PC to the camera, follow the steps below. When you upload the file, **the parameters in the uploaded file will overwrite the current parameter settings in the camera.**

1. Click the **Config Management** button.
2. A **Configuration Management** dialog box will open as shown below. Click the **Browse** button in the dialog box.

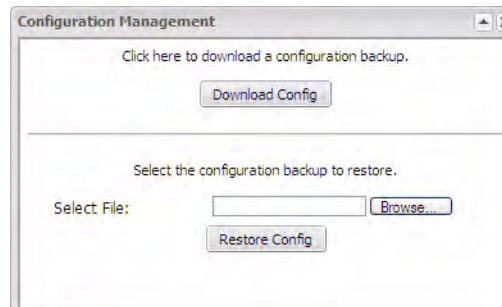

3. A **Choose File** dialog box will open as shown below. Navigate to the location of the saved file, select the file, and click the **Open** button.

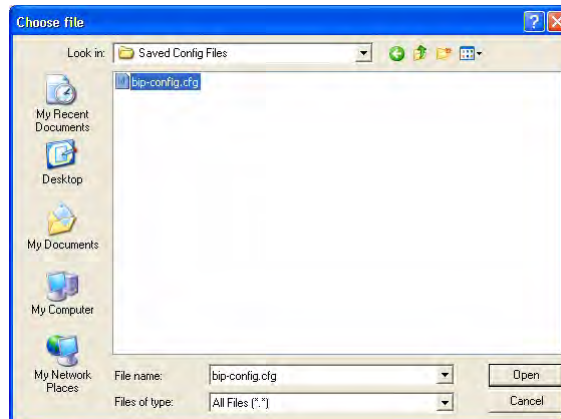

4. Click the **Restore Config** button in the **Configuration Management** dialog box.
5. The file will be uploaded from the PC to the camera. When the **Are you sure?** message window appears, click the **Yes** button.
6. The parameters in the file will be applied to the camera and the web client will restart. When the restart is done, the procedure is complete.

Start Firmware Update

Occasionally, firmware updates may be made available to the field. The **Start Firmware Update** button is used to start the firmware update process.

To determine the version of the firmware currently in your camera, access the **Info** tab (see [page 53](#)).

To see if a new firmware version is available, go to our website:

www.basler-ipcam.com

If newer firmware is available, download it to your computer. Note that the firmware is different for each camera model, so be sure to download the appropriate firmware for your model.



If you are updating from version 1.2-0 firmware or below, the network settings currently in the camera will be lost when you do the update. The camera will revert to the default network settings when the update is complete. In this situation you must use the Basler BIP Finder software to locate your camera on the network after the update is done, and you must use the Basler Surveillance Web Client to reset your network settings as you desire.

Once you have installed version 1.3-0 firmware or higher on your camera, this behavior will be changed and the camera will retain its network settings during an update.



The Basler IP Camera Finder software (version 1.4 or higher) can also be used to update the firmware. An advantage of the BIP Finder software is that it can be used to simultaneously update multiple cameras.

You can download the Basler IP Camera Finder software at:

www.basler-ipcam.com

If you have downloaded a new firmware update file from the website, you can update the firmware in your camera by following this procedure:

1. Click the **Start Firmware Update** button.
2. A **Firmware Upload** dialog box will open as shown below. Click the **Browse** button in the dialog box.



3. A **Choose File** dialog box will open as shown below. Navigate to the location of the downloaded firmware file, select the file, and click the **Open** button.

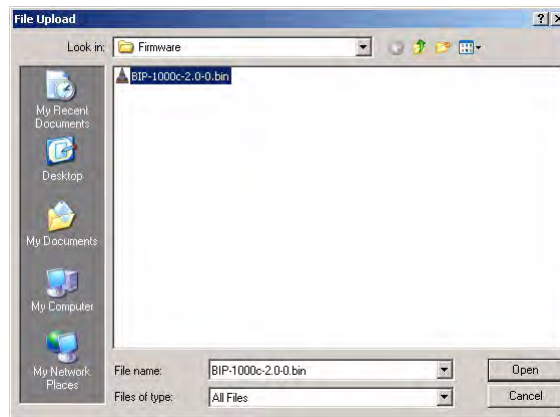

4. Click the **Upload** button on the **Firmware Upload** dialog box. A message will appear indicating that the firmware is being uploaded from your PC to your camera.
5. When the upload is complete, an **Are you sure?** message window will appear showing the version number of the current firmware and the version number of the update file as shown below. As the message indicates, **doing a firmware update is not reversible!**
 - If the **Keep All Settings** check box is checked, all current configuration settings will be retained when the update is done.
 - If the **Keep All Settings** check box is cleared, all configuration settings will be reset to factory defaults except for the network and user settings (the current network and user settings will be retained).

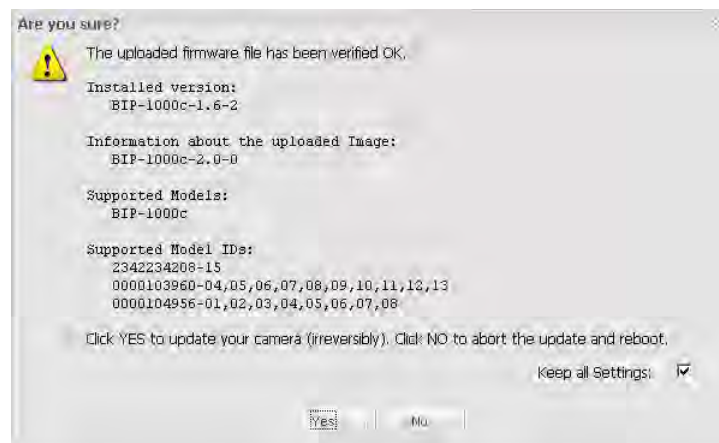

NOTE: IN THE FOLLOWING STEPS, DO NOT DISCONNECT THE CAMERA FROM POWER OR FROM THE NETWORK WHILE THE UPDATE IS IN PROGRESS. If you do disconnect power or the network connection during the update, the firmware update will fail, the camera will no longer operate, and the camera will not be repairable in the field.

6. Click the **Yes** button in the **Are you sure?** message window to start the update or the **No** button to cancel the update.
7. If you clicked the **Yes** button a message will appear indicating that the firmware update is in progress.
8. Once the update is complete, the camera will reboot and the web client will reopen in your browser.



If your browser times out during the update process, press the Ctrl and F5 keys (at the same time) to refresh the browser.

If you accidentally close the browser during the firmware update, wait several minutes and then reopen the browser. The update will be performed even with the browser closed.

4 Reset Tool

A reset tool is available that will let you reset the camera via its RS-232 serial connection. This tool is especially useful if you have enabled user management on the camera and you can no longer remember your administrative password. The tool resets all of the camera's parameters to factory defaults.

A cable that connects from the RS-232 connector on a PC to the camera's terminal connector is required to use the tool. The instructions included with the tool include information about how to wire the cable.

You can download the tool from our website: www.basler-ip.com.

5 The Terminal Connector

The 6-pin terminal connector on the back of the camera can be used to:

- provide power to the camera (when PoE is not used).
- access the camera's input line.
- access the camera's output line.
- access the camera's RS-232 connection.

The terminal connector on the camera is a Phoenix header (part number 1881480).

The recommended mating connector is a 6-pin Phoenix plug (part number 1881367). A Phoenix plug of this type is included with each camera.

NOTICE

Do not apply AC voltages or voltages out of specification to the camera.

1. Apply only DC voltages. Applying AC voltages can seriously damage the camera.
2. Make sure that the voltages are within the limits specified in Table 3 on [page 66](#). Applying voltages outside of the specifications can seriously damage the camera.

The pin numbering for the terminal connector on the camera is as shown below.

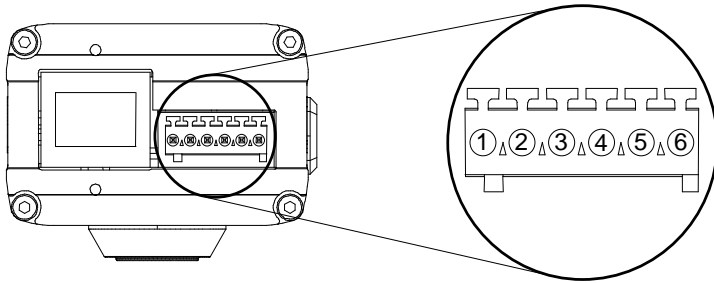

Fig. 5: Terminal Connector Pin Numbering

The pinout for the terminal connector is as described in Table 3.

Pin	Function	Description																														
1	Ground	Ground (for camera power, for the I/O signals, and for the RS-232 serial port)																														
2	Camera Power	Use this connection to supply power to the camera (if you are not supplying camera power via PoE). Nominal operating voltage: +12 VDC Voltage applied: between +7 and +20 VDC Maximum power consumption: 5 W																														
3	Input	<p>Normally, the input is connected to ground via a switch as shown in Figure 6 on page 68. As shown in the table below, the input will be detected by the camera as active or inactive depending on whether the switch is open or closed and whether the input mode is set to normal or inverted. See Section 3.8.1 on page 45 for more information about setting the input mode.</p> <table border="1"> <thead> <tr> <th>Switch Condition</th> <th>Input Mode</th> <th>Input Detected As</th> </tr> </thead> <tbody> <tr> <td>Open</td> <td>Normal</td> <td>Inactive</td> </tr> <tr> <td>Closed</td> <td>Normal</td> <td>Active</td> </tr> <tr> <td>Open</td> <td>Inverted</td> <td>Active</td> </tr> <tr> <td>Closed</td> <td>Inverted</td> <td>Inactive</td> </tr> </tbody> </table> <p>As an alternative, voltage from a device can be applied directly to the input. As shown in Figure 7 on page 69, the voltage should be applied directly to the input and not through a switch. As shown in the table below, the input will be detected by the camera as active or inactive depending on the voltage level applied and whether the input mode is set to normal or inverted.</p> <table border="1"> <thead> <tr> <th>Voltage Applied</th> <th>Input Mode</th> <th>Input Detected As</th> </tr> </thead> <tbody> <tr> <td>0 to +2.6 VDC</td> <td>Normal</td> <td>Active</td> </tr> <tr> <td>+5.7 to +24.0 VDC</td> <td>Normal</td> <td>Inactive</td> </tr> <tr> <td>0 to +2.6 VDC</td> <td>Inverted</td> <td>Inactive</td> </tr> <tr> <td>+5.7 to +24.0 VDC</td> <td>Inverted</td> <td>Active</td> </tr> </tbody> </table> <p>The area between +2.6 and +5.7 is a transition zone and should be avoided. The voltage applied to the input must not exceed +24 VDC.</p>	Switch Condition	Input Mode	Input Detected As	Open	Normal	Inactive	Closed	Normal	Active	Open	Inverted	Active	Closed	Inverted	Inactive	Voltage Applied	Input Mode	Input Detected As	0 to +2.6 VDC	Normal	Active	+5.7 to +24.0 VDC	Normal	Inactive	0 to +2.6 VDC	Inverted	Inactive	+5.7 to +24.0 VDC	Inverted	Active
Switch Condition	Input Mode	Input Detected As																														
Open	Normal	Inactive																														
Closed	Normal	Active																														
Open	Inverted	Active																														
Closed	Inverted	Inactive																														
Voltage Applied	Input Mode	Input Detected As																														
0 to +2.6 VDC	Normal	Active																														
+5.7 to +24.0 VDC	Normal	Inactive																														
0 to +2.6 VDC	Inverted	Inactive																														
+5.7 to +24.0 VDC	Inverted	Active																														

Table 3: Terminal Connector Pin Functions

Pin	Function	Description															
4	Output	<p>The output employs an open collector transistor connected to ground as shown in Figure 6 on page 68. As shown below, the output will or will not be connected to ground via the transistor depending on the state of the output and whether the output is set for the normal or the inverted mode.</p> <p>See Section 3.8.1 on page 45 for more information about setting the output mode.</p> <p>Note: If the output has been set to the inverted mode and you restart the camera or you power it off and back on, the output will be in the normal mode during the camera bootup process and will return to the inverted mode once the bootup process is complete.</p> <table border="1"> <thead> <tr> <th>Output State</th> <th>Output Mode</th> <th>Output Connected to Ground</th> </tr> </thead> <tbody> <tr> <td>Inactive</td> <td>Normal</td> <td>No</td> </tr> <tr> <td>Active</td> <td>Normal</td> <td>Yes</td> </tr> <tr> <td>Inactive</td> <td>Inverted</td> <td>Yes</td> </tr> <tr> <td>Active</td> <td>Inverted</td> <td>No</td> </tr> </tbody> </table> <p>The maximum load is 100 mA and the maximum voltage is +24 VDC.</p> <p>If an inductive load such as a relay is used with the output, a diode must be connected in parallel with the load as shown in Figure 6.</p>	Output State	Output Mode	Output Connected to Ground	Inactive	Normal	No	Active	Normal	Yes	Inactive	Inverted	Yes	Active	Inverted	No
Output State	Output Mode	Output Connected to Ground															
Inactive	Normal	No															
Active	Normal	Yes															
Inactive	Inverted	Yes															
Active	Inverted	No															
5	RS-232 Transmit	<p>RS-232 transmit.</p> <p>Note: RS-232 transmit on the camera should be connected to RS-232 receive on your device.</p>															
6	RS-232 Receive	<p>RS-232 receive.</p> <p>Note: RS-232 receive on the camera should be connected to RS-232 transmit on your device.</p>															

Table 3: Terminal Connector Pin Functions

We recommend that connections to the input and the output be made with shielded cable and that the cable shields be connected to ground. If you are unable to connect the cable shields to ground or if you use unshielded cable, we recommend that you install a ferrite bead on each cable near to the camera to minimize electromagnetic interference.

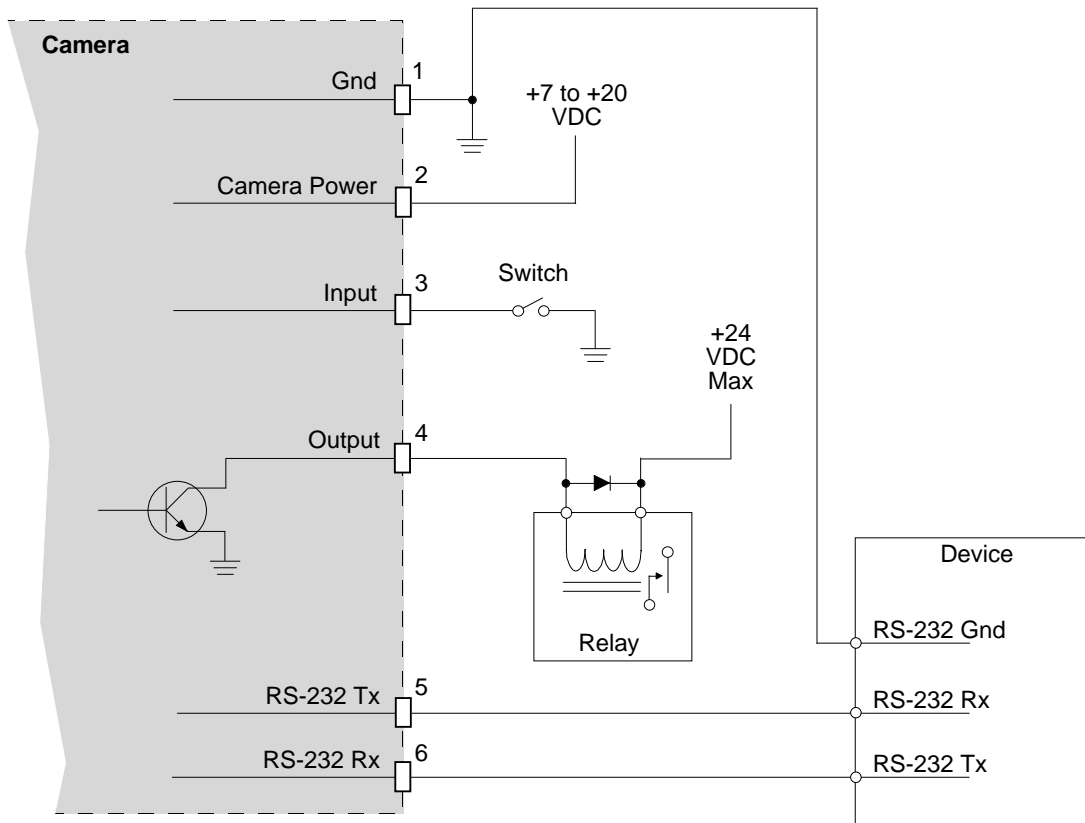

Fig. 6: Switched Ground Input

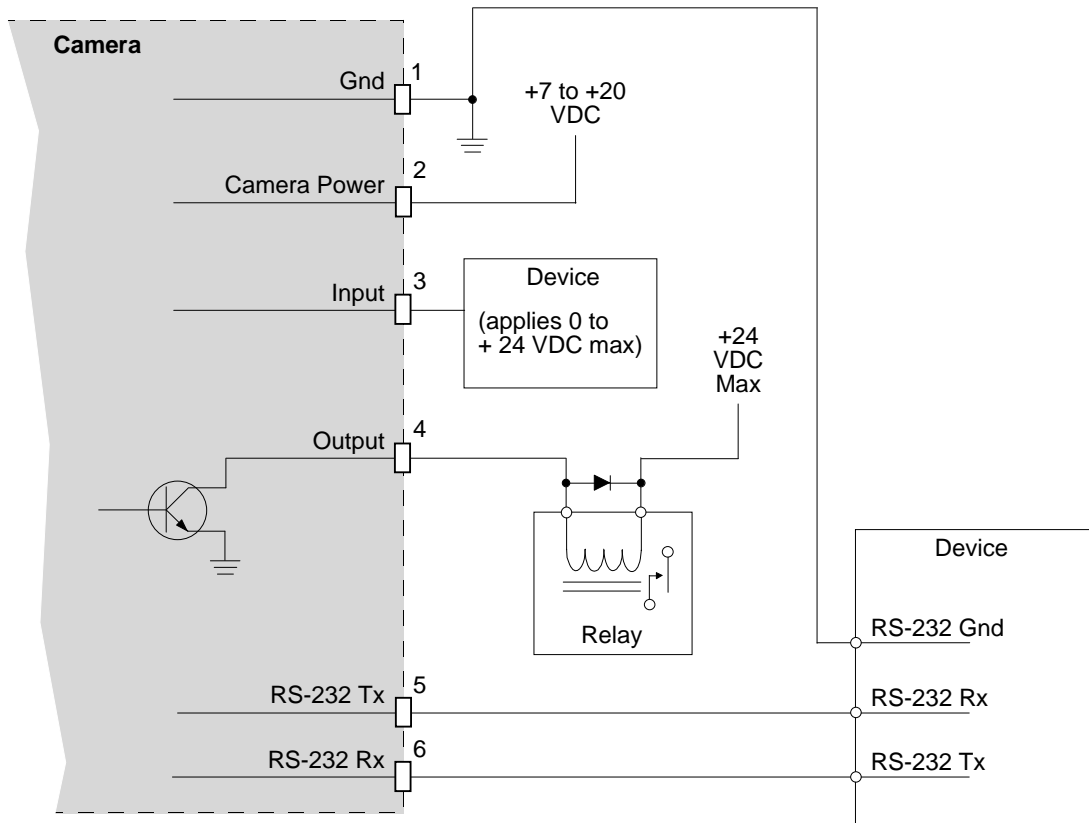

Fig. 7: Direct Device Input

6 Day/Night Functionality

6.1 Introduction

Basler IP Cameras with the letters "dn" at the end of the model name (e.g., BIP-640c-dn) are equipped with day/night functionality. Cameras with day/night functionality are well-suited for use in areas with natural lighting during the day and artificial lighting at night. And when used with a supplemental IR illuminator, these cameras can produce high-quality images in areas with little visible light, which makes them very useful in applications with poor lighting.

During daylight, a day/night camera delivers color images. As evening approaches and the daylight level decreases, the camera can automatically switch to night mode. In night mode, the camera makes use of near-infrared (IR) light to deliver high-quality black and white images.

Daylight includes both visible light and near-infrared light. Visible light ranges in wavelength from about 400 to 750 nanometers and near-IR light from about 750 to 1000 nanometers. Unlike the human eye, the sensor in color IP cameras is sensitive to both visible light and to near-infrared light. During the daytime, the camera's sensitivity to near-infrared light causes a problem; near-infrared light distorts the colors in the captured images as perceived by the human eye. To avoid this problem, the cameras include an IR-cut filter located in front of the imaging sensor. This filter blocks the near-infrared light present in daylight and ensures proper colors in the captured images.

Day/night cameras include a mechanical mechanism that allows the IR-cut filter to be automatically removed from in front of the sensor. So when daylight decreases as evening approaches, the day/night camera senses the change, it goes into night mode, and the internal mechanism in the camera removes the IR-cut filter from in front of the sensor. This allows the camera to use any available near-infrared light to produce black and white images. An IR illuminator that provides infrared light can be placed in the area where the camera is located to enhance its ability to produce high-quality images in low light or in nighttime conditions.

Definitions

When referring to the camera's IR-cut filter:

- the terms **closed** or **in the closed position** mean that the mechanical mechanism in the camera has placed the IR-cut filter in front of the sensor.
- the terms **open** or **in the open position** mean that the mechanical mechanism in the camera has removed the IR-cut filter from in front of the sensor.

IR-Cut Filter Modes of Operation

The IR-cut filter mechanism in the camera has several modes of operation:

- In **Auto** mode, the camera automatically senses the change from night to day or from day to night. When a day-to-night change is detected, the camera will automatically move the filter to the open position. And when a night-to-day change is detected, the camera will automatically move the filter to the closed position. (see below for more information on how the auto mode works).
- In **Open** mode, the IR-cut filter will be placed in the open position and kept there.
- In **Closed** mode, the IR-cut filter will be placed in the closed position and kept there.
- In **Input Pin 0 Controlled** mode, the state of input pin 0 will control whether the IR-cut filter is open or closed. When the input is active, the filter will be open. And when the input is inactive, the filter will be closed.

You can use the Day/Night tab in the Image Controls parameters (see [page 16](#)) group to set the IR Filter Mode.

How the IR-Cut Filter Auto Mode Works

When the IR-cut filter is set to auto mode, the camera automatically detects the change from day to night or from night to day and positions the IR-cut filter accordingly.

The IR-cut filter auto controls work by monitoring the "darkness level" in the scene that the camera is viewing. If the scene is very dark it will have a high darkness level. And if the scene is very bright, it will have a very low or even a negative darkness level.

As an example, assume that the camera is viewing a daytime scene and that the IR-cut filter is closed. Because it is daytime, the darkness level measured by the auto controls will be very low. As night approaches, the scene will become darker and the measured darkness level will gradually rise. Once the measured darkness level rises above a specified "switch level" and remains there for a period of time, the auto controls will assume that it is night and will change the camera to night mode (i.e., open the IR-cut filter).

Now assume that the camera is viewing a nighttime scene and that the IR-cut filter is open. Because it is nighttime, the darkness level measure by the auto controls will be high. As day approaches, the scene will become brighter and the measured darkness level will gradually fall. Once the measured darkness level falls below the "switch level" and remains there for a period of time, the auto controls will assume that it is day and will change the camera to day mode (i.e., close the IR-cut filter).

The camera's **IR Filter Switch Level** parameter lets you set the switch level. The higher you set the switch level, the darker it must be before the camera will switch from day mode to night mode.

The camera's **IR Filter Wait Time** parameter lets you set the time period (in seconds) that the measured darkness level must remain above the switch level before the auto controls will decide that it is nighttime and switch the camera to night mode. The parameter also sets the time period that the measured darkness level must remain below the switch level before the auto controls will decide that it is daytime and switch the camera to day mode. This parameter helps to keep the auto controls from mistakenly sensing a momentary change in lighting conditions as a change from night to day or from day to night.

Finally, the **IR Filter current Level** parameter lets you see the current darkness level as measured by the auto controls. Familiarizing yourself with how this value changes when the camera is viewing a dark scene and when it is viewing a bright scene will help you determine where the switch level should be set.

You can use the Day/Night tab in the Image Controls parameters group (see [page 16](#)) to set the IR Filter Switch Level and IR Filter Wait Time parameters and to monitor the IR Filter Current Level parameter.

The IR-Cut Filter Announce Feature

The IR-cut filter has a capability called the "announce feature". When the Output Pin Function parameter on the Digital I/O tab (see [page 45](#)) is set to "IR Filter Announce", the announce feature will be enabled. When the announce feature is enabled, the camera will "announce" the current position of the IR-cut filter by setting the state of output pin 0:

- If the IR-cut filter is in the open position, output pin 0 will be set to active.
- If the IR-cut filter is in the closed position, output pin 0 will be set to inactive.

6.2 IR-Cut Filter Control Options

Controlling the IR-Cut Filter Position Via Input Pin 0

As mentioned in Section 6.1 on [page 71](#), the IR-cut filter can be set for several different modes of operation. If you set the IR-cut filter mode to "Input Pin 0 Controlled" this will let you control the position of the IR-cut filter (open or closed), by inputting a signal into input pin 0 on the camera. When the input is active, the filter will be placed in the open position. And when the input is inactive, the filter will be placed in the closed position.

At night or in low light situations, you may be using an "IR illuminator" to illuminate the area being viewed by you camera with infrared light. Many IR illuminators include a photocell that detects the change from day to night and from night to day. Often, the photocell in an illuminator will be associated with an internal switch that opens and closes based on the conditions detected by the photocell. As illustrated in Figure 8, when the IR-cut filter mode is set to "Input Pin 0 Controlled", an internal switch such as this can be connected to input pin 0 on the camera and used to control the position of the IR-cut filter.

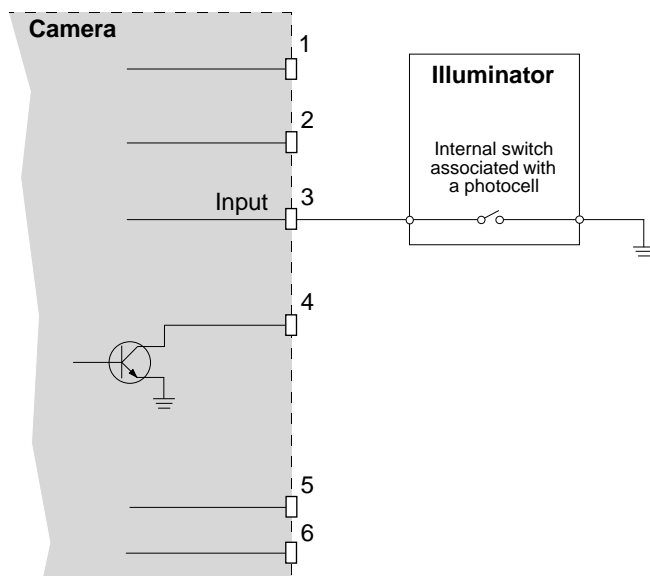

Fig. 8: Input Used to Control IR-Cut Filter Position

NOTICE

The text in this section and the illustration shown in Figure 8 are intended as a general description of how you can use the input to control the IR-cut filter position. Any device that you attach to the input of the camera must adhere to the specifications for the input as given in Table 3 on [page 66](#). **Using the input in a way that does not meet specifications can result in severe damage to the camera.**

1. Always make sure that any circuit attached to the input meets the input's specifications.

Controlling an External Device Based on the IR-Cut Filter Position

As mentioned on [page 73](#), the camera includes a capability called the IR-cut filter announce feature. When this feature is enabled, the camera will "announce" the current position of the IR-cut filter by setting the state of output pin 0. When the IR-cut filter is in the open position, output pin 0 will be set to active. And when the IR-cut filter is in the closed position, output pin 0 will be set to inactive.

A common way to use this capability is to set the IR-cut filter to "auto" mode and to use output pin 0 to switch an IR illuminator on and off. Figure 9 shows a simple way that this can be done. In the figure, the output is used to energize or de-energize a relay which in turn applies power to or removes power from an IR illuminator. You could use a setup such as this to apply power to the illuminator when the filter is in the open position at night and to remove power from the illuminator when the filter is in the closed position during the day.

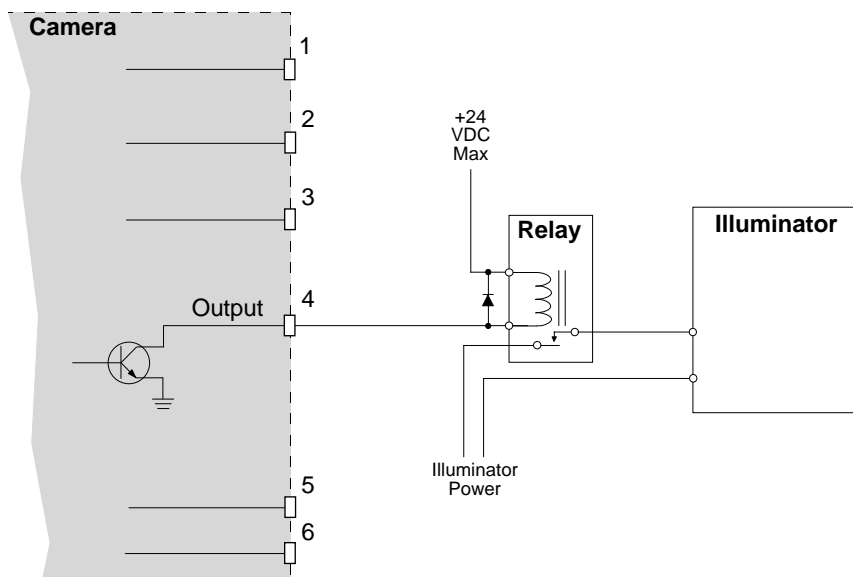

Fig. 9: Output Used to Apply Device Power

NOTICE

The text in this section and the illustration shown in Figure 9 are intended as a general description of how you can use the output to control an external device. Any device that you attach to the output of the camera must adhere to the specifications for the output as given in Table 3 on [page 66](#). **Using the output in a way that does not meet specifications can result in severe damage to the camera.**

1. Always make sure that any circuit attached to the output meets the output's specifications.

7 Technical Specifications

7.1 BIP-640c and BIP1000c Specifications

Specification	BIP-640c	BIP-640c-dn	BIP-1000c	BIP-1000c-dn		
Sensor	Sony ICX424 1/3" progressive scan color CCD		Sony ICX204 1/3" progressive scan color CCD			
Effective Pixels	640 (H) x 480 (V)		1024 (H) x 768 (V)			
Pixel Size	7.4 μm x 7.4 μm		4.65 μm x 4.65 μm			
Frame Rate	MJPEG	MPEG-4	H.264	MJPEG	MPEG-4	H.264
Full resolution:	30 fps	30 fps	25 fps	18 fps	11 fps	10 fps
D1 (720 x 480):	30 fps*	30 fps*	25 fps*	30 fps*	30 fps*	25 fps*
	* scaled (Max sensor readout rate = 71 fps)			* via AOI (Max sensor readout rate = 30 fps)		
Minimum Illumination	0.35 lux (F1.0, 33 ms)	0 Lux, IR sensitive	1.3 lux (F1.0, 33 ms)	0 Lux, IR sensitive		
Lens Mount	CS-mount, DC Iris drive (lens not included)					
IR-Cut Filter	Fixed filter	Automatically removable filter	Fixed filter	Automatically removable filter		
Image Settings	Automatic gain, exposure area, backlight compensation, white balance, electronic shutter, 180° image rotation, electronic PTZ via AOI (API), text overlay, privacy masks, motion detection					
Resolutions	From 64 x 64 to 640 x 480 (free scaling), 4:3, 16:9 Multiple Areas of Interest (AOIs)		From 64 x 64 to 1024 x 768 (free scaling), 4:3, 16:9 Multiple Areas of Interest (AOIs)			
Video Compression	Motion JPEG: Multiple compression Levels MPEG-4: SP (Level 3), ASP (Level 5) H.264 (MPEG-4 AVC): Baseline (Level 3)					
Video Streaming	Simultaneous dual encoding for MJPEG and MPEG-4 or H.264 Multi-streaming for MJPEG VBR and CBR for MJPEG, MPEG-4, and H.264 Multicast and unicast					

Table 4: BIP640c and BIP-1000c Technical Specifications

Specification	BIP-640c	BIP-640c-dn	BIP-1000c	BIP-1000c-dn
Alarm Management	Ring buffer for pre and post alarm Events triggered by motion detection or external input Image upload via FTP, Email, or HTTP			
Protocols	TCP/IP, HTTP, FTP, UDP, ICMP, ARP, DHCP, NTP, RTP, RTSP, RTCP, SMTP, IGMP, ZEROCONF, QoS Layer 3			
Processor / Memory	600 MHz dual core multimedia DSP, FPGA 128 MB RAM, 8 MB Flash			
Minimum PC Requirements	Pentium 4, 2.4 GHz or higher, 256 MB RAM or more AGP Graphics card, 64 MB RAM or more 1280 x 1024 display or better 100 Mbps NIC Win 2k, XP, Vista, Windows 7, or Server 2003 OS Internet Explorer 6.0 or higher			
Power	PoE (Power over Ethernet IEEE 802.3af) or + 7 to + 20 VDC Power consumption is 5 W max at 12 VDC			
Connectors	Screwable RJ-45 connector for 10/100 Base-T Ethernet, full or half duplex 6-pin Phoenix terminal for DC power, digital I/O, and RS-232			
Operating Conditions	0° to 50° C (32° to 122° F) < 90% relative humidity (non condensing)			
Standards	FCC Class B, CE, RoHS			
Housing	89.9 mm x 29 mm x 44 mm, full metal casing			
Weight	~ 230 g			

Table 4: BIP640c and BIP-1000c Technical Specifications

7.2 BIP-1300c and BIP-1600c Specifications

Specification	BIP-1300c	BIP-1300c-dn	BIP-1600c	BIP-1600c-dn		
Sensor	Sony ICX445 1/3" progressive scan color CCD		Sony ICX274 1/1.8" progressive scan color CCD			
Effective Pixels	1280 (H) x 960 (V)		1600 (H) x 1200 (V)			
Pixel Size	3.75 μm x 3.75 μm		4.4 μm x 4.4 μm			
Frame Rate	MJPEG	MPEG-4	H.264	MJPEG	MPEG-4	H.264
Full resolution:	11 fps	9 fps	7 fps	8 fps	5 fps	4 fps
D1 (720 x 480):	30 fps*	25 fps*	25 fps*	30 fps*	25 fps*	25 fps*
	* via AOI (Max sensor readout rate = 30 fps)			* via AOI (Max sensor readout rate = 12.5 fps)		
Minimum Illumination	0.95 lux (F1.0, 33 ms)	0 Lux, IR sensitive	0.83 lux (F1.4, 33 ms)	0 Lux, IR sensitive		
Lens Mount	CS-mount, DC Iris drive (lens not included)		C-mount with adapter ring (lens not included)	C-mount with adapter ring (lens included: DC iris-IR 1.4/10-40mm)		
IR-Cut Filter	Fixed filter	Automatically removable filter	Fixed filter	Automatically removable filter		
Image Settings	Automatic gain, exposure area, backlight compensation, white balance, electronic shutter, 180° image rotation, electronic PTZ via AOI (API), text overlay, privacy masks, motion detection					
Resolutions	From 64 x 64 to 1280 x 960 (free scaling), 4:3, 16:9 Multiple Areas of Interest (AOIs)		From 64 x 64 to 1600 x 1200 (free scaling), 4:3, 16:9 Multiple Areas of Interest (AOIs)			
Video Compression	Motion JPEG: Multiple compression Levels MPEG-4: SP (Level 3), ASP (Level 5) H.264 (MPEG-4 AVC): Baseline (Level 3)					
Video Streaming	Simultaneous dual encoding for MJPEG and MPEG-4 or H.264 Multi-streaming for MJPEG VBR and CBR for MJPEG, MPEG-4, and H.264 Multicast and unicast					
Alarm Management	Ring buffer for pre and post alarm Events triggered by motion detection or external input Image upload via FTP, Email, or HTTP					
Protocols	TCP/IP, HTTP, FTP, UDP, ICMP, ARP, DHCP, NTP, RTP, RTSP, RTCP, SMTP, IGMP, ZEROCONF, QoS Layer 3					

Table 5: BIP-1300c and BIP-1600c Technical Specifications

Specification	BIP-1300c	BIP-1300c-dn	BIP-1600c	BIP-1600c-dn
Processor / Memory	600 MHz dual core multimedia DSP, FPGA 128 MB RAM, 8 MB Flash Battery backed-up real time clock			
Minimum PC Requirements	Pentium 4, 2.4 GHz or higher, 256 MB RAM or more AGP Graphics card, 64 MB RAM or more 1280 x 1024 display or better 100 Mbps NIC Win 2k, XP, Vista, Windows 7, or Server 2003 OS Internet Explorer 6.0 or higher			
Power	PoE (Power over Ethernet IEEE 802.3af) or + 7 to + 20 VDC Power consumption is 5 W max at 12 VDC			
Connectors	Screwable RJ-45 connector for 10/100 Base-T Ethernet, full or half duplex 6-pin Phoenix terminal for DC power, digital I/O, and RS-232			
Operating Conditions	0° to 50° C (32° to 122° F) < 90% relative humidity (non condensing)			
Standards	FCC Class B, CE, RoHS			
Housing	89.9 mm x 29 mm x 44 mm, full metal casing			
Weight	~ 230 g			

Table 5: BIP-1300c and BIP-1600c Technical Specifications

7.3 Stress Test Results

Basler IP Cameras were submitted to an independent mechanical testing laboratory and subjected to the stress tests listed below. After mechanical testing, the cameras produced normal images during standard operational testing.

Test	Standard	Conditions
Vibration (sinusoidal, each axis)	DIN EN 60068-2-6	10-58 Hz / 1.5 mm_58-500 Hz / 20 g_1 octave/minute 10 repetitions
Shock (each axis)	DIN EN 60068-2-27	20 g / 11 ms / 10 shocks positive 20 g / 11 ms / 10 shocks negative
Bump (each axis)	DIN EN 60068-2-29	20 g / 11 ms / 100 shocks positive 20 g / 11 ms / 100 shocks negative
Vibration (broad-band random, digital control, each axis)	DIN EN 60068-2-64	15-500 Hz / 0.05 PSD (ESS standard profile) / 00:30 h

Table 6: Mechanical Stress Tests

Appendix A Software License Information

MPEG-4:

THIS PRODUCT IS LICENSED UNDER THE MPEG-4 VISUAL PATENT PORTFOLIO LICENSE FOR THE PERSONAL AND NON-COMMERCIAL USE OF A CONSUMER FOR (i) ENCODING VIDEO IN COMPLIANCE WITH THE MPEG-4 VISUAL STANDARD ("MPEG-4 VIDEO") AND/OR (ii) DECODING MPEG-4 VIDEO THAT WAS ENCODED BY A CONSUMER ENGAGED IN A PERSONAL AND NONCOMMERCIAL ACTIVITY AND/OR WAS OBTAINED FROM A VIDEO PROVIDER LICENSED BY MPEG LA TO PROVIDE MPEG-4 VIDEO. NO LICENSE IS GRANTED OR SHALL BE IMPLIED FOR ANY OTHER USE. ADDITIONAL INFORMATION INCLUDING THAT RELATING TO PROMOTIONAL, INTERNAL AND COMMERCIAL USES AND LICENSING MAY BE OBTAINED FROM MPEG LA, LLC. SEE [HTTP://WWW.MPEGLA.COM](http://www.mpegla.com).

AVC (H.264)

THIS PRODUCT IS LICENSED UNDER THE AVC PATENT PORTFOLIO LICENSE FOR THE PERSONAL AND NON-COMMERCIAL USE OF A CONSUMER TO (i) ENCODE VIDEO IN COMPLIANCE WITH THE AVC STANDARD ("AVC VIDEO") AND/OR (ii) DECODE AVC VIDEO THAT WAS ENCODED BY A CONSUMER ENGAGED IN A PERSONAL AND NON-COMMERCIAL ACTIVITY AND/OR WAS OBTAINED FROM A VIDEO PROVIDER LICENSED TO PROVIDE AVC VIDEO. NO LICENSE IS GRANTED OR SHALL BE IMPLIED FOR ANY OTHER USE. ADDITIONAL INFORMATION MAY BE OBTAINED FROM MPEG LA, L.L.C. SEE [HTTP://WWW.MPEGLA.COM](http://www.mpegla.com).

Accordingly, please be advised that service providers, content providers, and broadcasters are required to obtain separate use licenses from MPEG LA prior to any use of AVC/MPEG-4/H.264 encoders and/or decoders.

Other Software

The camera contains software originating from a variety of third parties. To view the software license information:

1. Start the Surveillance Web Client as described in Section 2 on [page 5](#).
2. Click the **About** tab as shown below.
3. Click the **Copyright** link as shown below. A page containing license information will appear.

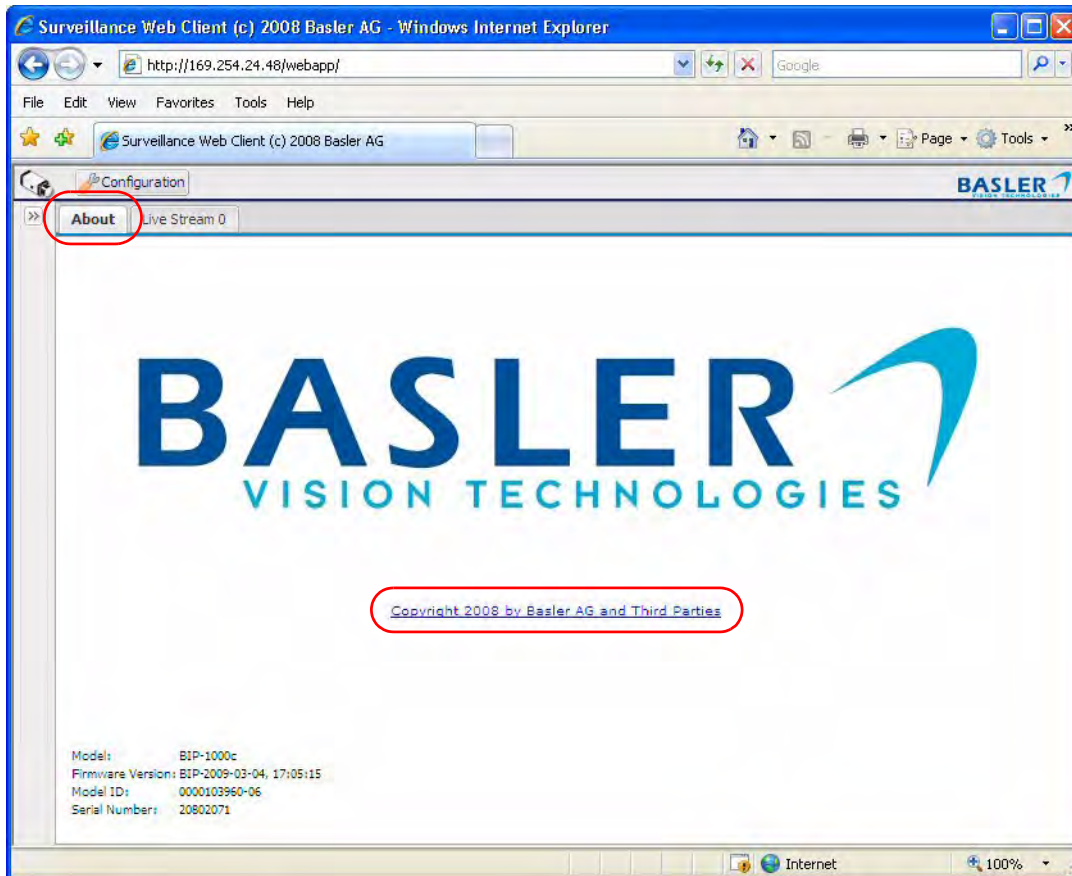

Revision History

Doc. ID Number	Date	Changes
AW00072101000	30 Jul 2008	Initial release of this document.
AW00072102000	19 Dec 2008	<p>Added information to Section 1.1 on page 1 pointing out the availability of firmware updates.</p> <p>Updated the web browser recommendation and the procedure for accessing the camera in Section 2 on page 5.</p> <p>Added the Sharpness parameter description to Section 3.3.1 on page 12.</p> <p>Added the Auto (limited) selection to the White Balance Mode parameter description in Section 3.3.1 on page 12.</p> <p>Added the Whitepoint X and Whitepoint Y parameter descriptions to Section 3.3.3 on page 16.</p> <p>Added the Stream Display parameter description to Section 3.4.1 on page 19.</p> <p>Added the H.264 selection to the Encoder Type parameter description in Section 3.4.2 on page 26.</p> <p>Added the GOP length parameter description and the Output Size parameter description to Section 3.4.2 on page 26.</p> <p>Expanded the description of the Encoder Mode setting in Section 3.4.2 on page 26.</p> <p>Added a description of how to use the Config Management button to Section 3.10.3 on page 56.</p> <p>Expanded the description of how to use the Start Firmware Update button in Section 3.10.3 on page 56.</p> <p>Updated the technical specifications for the BIP-1000c and added the technical specifications for the BIP-640c to Section 7.1 on page 77.</p> <p>Updated the technical specifications for the BIP-1600c and added the technical specifications for the BIP-1300c to Section 7.2 on page 79.</p> <p>Added the stress test results in Section 7.3 on page 81.</p> <p>Added H.264 licensing information to "Software License Information" on page 83.</p>

Doc. ID Number	Date	Changes
AW00072103000	24 Mar 2009	<p>Added the WEEE information to page 2.</p> <p>Updated the description on page 11 of the Refresh Rate and added a description of the Plugin Help button.</p> <p>Updated the description on page 12 of the Manual setting for the Exposure Mode parameter.</p> <p>Added descriptions of the new Shutter Mode and Gain Mode parameters to page 16.</p> <p>Expanded the notes about the configuration mode that appear on page 18.</p> <p>Added a note to page 27 indicating that steam 1 must be enabled in order to enable stream 2.</p> <p>Added a description of the new Email Port parameter to page 38.</p> <p>Added a description of the new FTP Port parameter to page 39.</p> <p>Added a description of the new HTTP Port parameter to page 42.</p> <p>Added descriptions of the new Multicast OnDemand and Multicast TTL parameters to page 43.</p> <p>Added descriptions of the new Input Pin Mode and Output Pin Mode parameters to page 45.</p> <p>Added Section 3.9 on page 47 describing the new user management functionality.</p> <p>Updated Table 3 on page 66 to describe the normal and the inverted modes available on the input pin and the output pin.</p> <p>Added the minimum PC requirements to Table 4 on page 77 and Table 5 on page 79.</p> <p>Updated the software license information page 83.</p> <p>Updated all screen shots.</p>
AW00072104000	8 Apr 2009	<p>Added a description of the new Saturation parameter to page 12.</p> <p>Added a description of the new IR Filter Mode parameter to page 16.</p> <p>Added a description of the new IR Filter Announce Mode parameter to page 45.</p> <p>Added Section 6 on page 71 describing day/night camera functionality.</p> <p>Updated Table 4 on page 77 and Table 5 on page 79 to include the new day/night cameras.</p>
AW00072105000	16 July 2009	<p>Added Section 3.3.1 on page 12 describing the new Exposure tab.</p> <p>Added Section 3.3.2 on page 15 describing the new Appearance tab.</p> <p>Added Section 3.3.3 on page 16 describing the new Day/Night tab.</p> <p>Updated the description on page 31 of the text overlay dialog box and the available expressions.</p> <p>Updated the description of the Network I/O tab in Section 3.7.4 on page 44.</p> <p>Added an explanation of how the IR-cut filter auto mode works to page 72.</p>

Doc. ID Number	Date	Changes
AW00072106000	28 Jan 2010	<p>Updated the firmware version level stated in Section 1.1 on page 1.</p> <p>Updated the WEEE information in Section 1.2 on page 2.</p> <p>Updated the description of the normal mode and the configuration mode in Section 3.1 on page 7.</p> <p>Added new settings for the Iris Mode parameter on page 13.</p> <p>Updated the introduction to streaming parameters in Section 3.4 on page 18.</p> <p>Updated the description of the Test Image Mode parameter on page 20.</p> <p>Added a description of the email Text Overlay button and the Email From parameter to page 38.</p> <p>Added a description of the FTP Text Overlay button and the FTP Remote Dir parameter to page 39.</p> <p>Added a description of how to add overlay text to alarm email and FTP images to page 40.</p> <p>Clarified the allowed address range for the Multicast IP parameter on page 43.</p> <p>Added Section 3.7.3 on page 44 describing the new QoS parameters.</p> <p>Added the new Output Pin Function parameter to Section 3.8.1 on page 45.</p> <p>Updated the time zone codes in Table 2 on page 55.</p> <p>Added Section 4 on page 63 describing the new reset tool.</p> <p>Updated the description of the IR-cut filter announce feature on page 73.</p> <p>Updated numerous screen shots to reflect new parameters and usability improvements.</p>
AW00072107000	25 Jun 2010	<p>Updated the contact information on the inside of the front cover.</p> <p>Updated the information in the Firmware portion of Section 1.1 on page 1 regarding the latest version of camera firmware.</p> <p>Added information to the Firmware portion of Section 1.1 on page 1 regarding the latest version of the BIP Finder software.</p> <p>Added a warning to Section 1.2 on page 2 regarding explosive atmospheres.</p> <p>Updated the Exposure tab screen shot in Section 3.3.1 on page 12.</p> <p>Added the description of the new Anti-Flicker parameter to page 13.</p> <p>Added information to the Exposure Time Limit parameter description on page 13 and the Gain Limit parameter on page 14 to indicate that these two parameters can be impacted by the Anti-Flicker parameter setting.</p> <p>Updated the Appearance tab screen shot in Section 3.3.2 on page 15.</p> <p>Renamed one of the settings on page 15 for the White Balance Mode parameter to "Automatic Preset".</p> <p>Added the new Red Gain and Blue Gain parameter descriptions to page 16.</p> <p>Updated the description of the "Reset to Factory Defaults" button on page 56.</p> <p>Added information about the latest version of the BIP Finder software and the new "Keep all settings" capability to the description of the firmware update procedure that starts on page 59.</p>

Feedback

Your feedback will help us improve our documentation. Please click the link below to access an online feedback form. Your input is greatly appreciated.

<http://www.baslerweb.com/umfrage/survey.html>

Index

A

adding a user.....	50
alarm actions.....	38
alarm buffer size parameter	30
alarm buffer state parameter	37
alarm buffers	37
alarm DSCP parameter	44
alarm handling parameters.....	36
alarm off delay parameter	35
alarm on delay parameter	35
alarm sources.....	36
anti-flicker parameter.....	13
area of interest, sensor.....	19
area of interest, stream	26
arm buffer button	37
authentication enabled parameter.....	47
authentication, serial port	46
authentication	47
auto brightness mask	23

B

backlight compensation parameter	13
baud rate parameter.....	46
baud rate, serial port	46
bitrate parameter	28
blue gain parameter	16
browser requirements.....	5

C

camera power via terminal connector	66
c-mount	3
configuration management.....	57
configuring the camera.....	7
constant bit rate mode.....	27
cs-mount.....	3

D

date & time tab	53
date time format parameter	53
day/night functionality.....	71
DC iris control.....	3
defaults, resetting to	56
deleting a user.....	50

DHCP parameter	42
digital I/O tab.....	45
digital in tab.....	36
digital output hold time parameter	38
digital output tab	38
disable buffer button	37

E

email parameter.....	38
email password parameter	38
email port parameter.....	38
email sender parameter.....	38
email server parameter.....	38
email tab	38
email username parameter.....	38
encoder mode parameter	27
encoder type parameter.....	27
exposure mode parameter.....	12
exposure offset parameter.....	13
exposure time (us) parameter.....	13, 14
exposure time limit parameter	13

F

factory defaults, resetting to.....	56
firmware updates	1, 59
firmware version parameter	53
forwarding parameter.....	46
forwarding, serial port	46
frame rate mode parameter.....	20
frame rate scaling parameter.....	29
frame rate, image capture.....	8
frame rate, stream	8
FTP password parameter	39
FTP port parameter	39
FTP remote dir parameter	39
FTP server parameter.....	39
FTP tab	39
FTP user name parameter.....	39

G

gain limit parameter	14
gain parameter.....	14
gamma parameter	15
global tab	19

-
- GOP length parameter 30
granularity parameter 34
ground 66
- H**
- H.264 27
history image frames parameter 34
host name parameter 42
HTTP DSCP parameter 44
http port parameter 42
HTTP tab 39
HTTP URL request parameter 39
- I**
- image controls parameters 12
image rotation parameter 20
include image parameter 39
info tab 53
input pin 66
input pin mode parameter 45
input pin parameter 45
input/output parameters 45
IP address parameter 42
IR filter current level parameter 17, 73
IR filter mode parameter 16
IR filter state parameter 16
IR filter switch level parameter 17, 72
IR filter wait time parameter 17, 72
IR-cut filter 71
iris mode parameter 13
- J**
- JPEG 27
- L**
- lens adapter 3
line configuration parameter 46
line configuration, serial port 46
live buffer size parameter 30
live images, viewing 5
- M**
- MAC address parameter 53
management tab 56
- managing users 49
manufacturer name parameter 53
masks
 auto brightness 23
 motion 25
 privacy 24
 white balance 22
MJPEG 27
model name parameter 53
motion detection mode parameter 34
motion detection parameters 34
motion JPEG 27
motion limit parameter 35
motion mask 25
motion tab 36
motion threshold parameter 35
MPEG4 27
multicast IP parameter 43
multicast on-demand parameter 43
multicast parameter 43
multicast port parameter 43
multicast TTL parameter 43
- N**
- name server parameter 42
network I/O tab 44
network parameters 42
network prefix parameter 42
network traffic in parameter 44
network traffic out parameter 44
NTP parameter 54
NTP server parameter 54
- O**
- output pin 67
output pin parameter 46
output scaling parameter 29
output size parameter 28
overlay position parameter 32, 41
overlay text
 email alarm images 38, 40
 FTP alarm images 39, 40
 streamed images 31
overlay text parameter 31, 40
- P**
- parameter settings, saving & restoring 57
-

passwords, changing.....	51
PoE.....	3
port parameter.....	46
port, serial.....	46
post alarm buffer size parameter.....	30
precautions.....	2
privacy mask.....	24

Q

QoS tab.....	44
quality parameter.....	28

R

red gain parameter.....	16
refresh rate.....	11
reset tool.....	63
restarting the camera.....	56
restoring parameter settings.....	57
rotation.....	20
RS-232 connection.....	67
RTSP DSCP parameter.....	44
RTSP enabled parameter.....	43
RTSP port parameter.....	43
RTSP tab.....	43

S

saturation parameter.....	15
saving parameter settings.....	57
sensitivity parameter.....	34
sensor AOI.....	19
sensor AOI editor.....	20, 21
sensor AOI height parameter.....	20
sensor AOI left parameter.....	20
sensor AOI top parameter.....	20
sensor AOI width parameter.....	20
serial I/O tab.....	46
serial number parameter.....	53
set date time parameter.....	53
settings tab.....	42
sharpness parameter.....	15
show motion parameter.....	34
software license info.....	83
specifications.....	71, 77
stream 0 tab (alarm buffer).....	37
stream 0 tab (video stream).....	26
stream 1 tab (alarm buffer).....	37
stream 2 tab (alarm buffer).....	37

stream AOI.....	26
stream AOI editor.....	33
stream AOI height parameter.....	29, 33
stream AOI left parameter.....	29
stream AOI top parameter.....	29
stream AOI width parameter.....	29
stream display parameter.....	21
streaming parameters.....	18
strobe delay parameter.....	45
strobe duration parameter.....	45
surveillance web client.....	5, 10
system log.....	56
system parameters.....	53

T

terminal connector	
description.....	65
location.....	3
pin numbering.....	66
test image mode parameter.....	20
text overlay	
email alarm images.....	38, 40
FTP alarm images.....	39, 40
streamed images.....	31
time zone description parameter.....	54

U

updating firmware.....	59
user level, changing.....	52
user management.....	47
user trigger tab.....	36
users	
adding.....	50
changing password.....	51
changing user level.....	52
deleting.....	50
managing.....	49

V

variable bit rate mode.....	27
video streams.....	19, 26

W

web browser.....	5
web browser requirements.....	5

white balance mask22
white balance mode parameter 15